



GAS RANGE

COS-965AGC

COS-965AGC-BK(S)

COS-965AGFC

COS-965AGFC-BK(S)

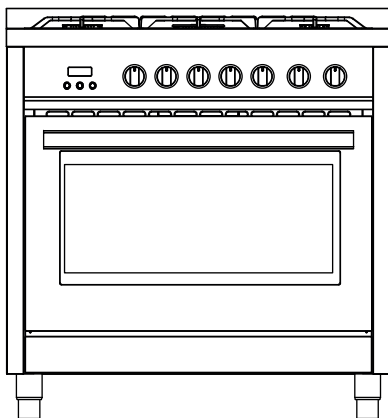
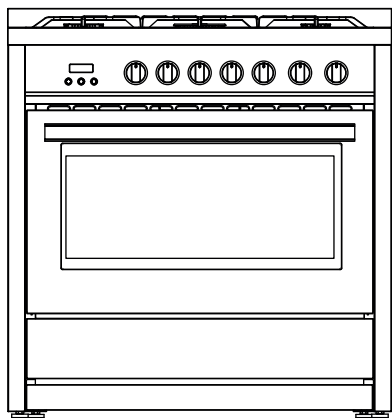

36" FREESTANDING/SLIDE-IN RANGE

USER MANUAL

IMPORTANT: READ AND SAVE THESE INSTRUCTIONS.
FOR RESIDENTIAL USE ONLY.

INSTALLER: PLEASE LEAVE THESE INSTRUCTIONS WITH THIS UNIT FOR
THE OWNER.

OWNER: PLEASE RETAIN THESE INSTRUCTIONS FOR FUTURE
REFERENCE.

THANK YOU FOR YOUR PURCHASE

Thank you for your purchase. We know that you have many brands and products to choose from and we are honored to know that you have decided to take one of our products into your home and hope that you enjoy it.

COSMO Appliances are designed according to the strictest safety and performance standard for the North American market. We follow the most advanced manufacturing philosophy. Each appliance leaves the factory after thorough quality inspection and testing. Our distributors and our service partners are ready to answer any questions you may have regarding how to install, use and care for your products. We hope that this manual will help you learn to use the product in the safest and most effective manner.

Before using this product, please read through this manual carefully. Keep this user manual in a safe place for future reference. Please ensure that other persons using this product are familiar with these instructions as well.

If you have any questions or concerns, please contact the dealer from whom you purchased the product, or contact our Customer Support at:

1-888-784-3108

Reach us online at:

www.cosmoappliances.com

TABLE OF CONTENTS

RANGE SAFETY	4
Anti-tip Device	7
Important Safety Instructions	8
OVERVIEW	12
Range Layout.....	12
Control Panel	14
FEATURES	15
Clock & Timer	15
Timed Cooking.....	17
OPERATION	21
Gas Surface Burners	21
Before Using the Gas Surface Burners	21
Using the Gas Surface Burners	22
Using the Wok Grate	24
Using the Proper Cookware	25
Oven	26
Before Using the Oven	26
Before Using the Oven for the First Time	27
Oven Vent.....	27
Oven Door	28
Using Oven Racks.....	28
Preheating.....	29
Oven Controls	30
Bake.....	32
Broil.....	33
Convection Bake	34
Tips and Techniques	35
RANGE CARE	40
Cleaning.....	40
TROUBLESHOOTING	44
LIMITED WARRANTY	49

RANGE SAFETY

READ ALL INSTRUCTIONS BEFORE USING THE APPLIANCE

Your safety and the safety of others are very important.

We have provided many important safety messages in this manual and on your appliance. Always read and obey all safety messages.



This is the safety alert symbol.

This symbol alerts you to potential hazards that can kill or hurt you and others.

All safety messages will follow the safety alert symbol and either the word "WARNING" or "CAUTION." These words mean:



You can be killed or seriously injured if you don't follow instructions.



A potentially hazardous situation which, if not avoided, could result in minor or moderate injury.

All safety messages will tell you what the potential hazard is, tell you how to reduce the chance of injury, and tell you what can happen if the instructions are not followed.

In the State of Massachusetts, the following installation instructions apply:

- Installations and repairs must be performed by a qualified or licensed contractor, plumber, or gasfitter qualified or licensed by the State of Massachusetts.
- If using a ball valve, it shall be a T-handle type.
- A flexible gas connector, when used, must not exceed 3 feet.

California Proposition 65 Warning



Cancer and Reproductive Harm - www.P65Warnings.ca.gov.

WARNING



FIRE AND EXPLOSION HAZARD

If the information in this manual is not followed exactly, a fire or explosion may result causing property damage, personal injury or death.

- Do not store or use gasoline or other flammable vapors and liquids in the vicinity of this or any other appliance.
- **WHAT TO DO IF YOU SMELL GAS**
 - Do not try to light any appliance.
 - Do not touch any electrical switch.
 - Do not use any phone in your building.
 - Clear the room, building, or area of all occupants.
 - Immediately call your gas supplier from a neighbor's phone. Follow the gas supplier's instructions.
 - If you cannot reach your gas supplier, call the fire department.
- Installation and service must be performed by a qualified installer, service agency or the gas supplier.

WARNING

Never Operate the Top Surface Cooking Section of this Appliance Unattended.

- Failure to follow this warning statement could result in fire, explosion, or burn hazard that could cause property damage, personal injury, or death.
- If a fire should occur, keep away from the appliance and immediately call your fire department.

DO NOT ATTEMPT TO EXTINGUISH AN OIL/GREASE FIRE WITH WATER.

WARNING

- Gas leaks cannot always be detected by smell. Gas suppliers recommend that you use a gas detector approved by UL or CSA. For more information, contact your gas supplier.
- Do not install a ventilation system that blows air downward toward this cooking appliance. This type of ventilation system may cause ignition and combustion problems with this cooking appliance resulting in personal injury or unintended operation.
- This appliance is intended for normal residential use. It is not approved for commercial use, outdoor installation, or any other application not specifically allowed by this manual.
- This appliance requires connection to a 3-prong, 120VAC single-phase (split-phase), 60Hz grounded electrical source protected by a 15- or 20-Amp circuit breaker or slow blow fuse. When installed, appliance must be electrically grounded in accordance with local codes or, in the absence of local codes, with the National Electrical Code, NFPA 70 or the Canadian Electric Code, CSA C22.1-02.
- Proper installation is the responsibility of the installer. Any adjustment and service should be performed only by qualified range installers or service technicians. The manufacturer is not responsible for any injury or damage that may result from incorrect or defective installation by unauthorized personnel.
- Product failure due to improper installation is not covered under warranty.

ANTI-TIP DEVICE

WARNING



TIP OVER HAZARD

- A child or adult can tip the range and be killed.
- Install anti-tip device to floor or wall per installation instructions.
- Slide range back so rear range foot is engaged in the slot of the anti-tip bracket or rear chains are connected to the anti-tip wall anchor hooks.
- Re-engage the anti-tip device if range is moved.
- Do not operate the range without anti-tip device installed and engaged.
- Failure to follow these instructions can result in death or serious burns to children and adults.

Making sure the anti-tip bracket is installed:

- Slide range forward.
- Look for the anti-tip device securely attached to floor or wall.
- Slide range back and make sure rear range foot is under anti-tip bracket or rear chains are connected to the anti-tip wall anchor hooks.

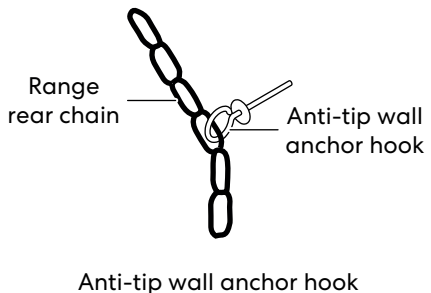
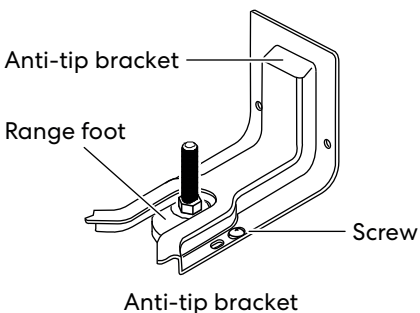

IMPORTANT SAFETY INSTRUCTIONS

WARNING: To reduce the risk of fire, electrical shock, injury to persons, or damage when using the range, follow basic precautions, including the following:

- **WARNING:** TO REDUCE THE RISK OF TIPPING OF THE RANGE, THE RANGE MUST BE SECURED BY PROPERLY INSTALLED ANTI-TIP DEVICES. TO CHECK IF THE DEVICES ARE INSTALLED PROPERLY, SLIDE RANGE COMPLETELY FORWARD, LOOK FOR ANTI-TIP BRACKET SECURELY ATTACHED TO THE FLOOR OR WALL, AND SLIDE RANGE BACK SO THE REAR RANGE FOOT IS UNDER ANTI-TIP BRACKET.
- **WARNING:** NEVER use this appliance as a space heater to heat or warm the room. Doing so may result in carbon monoxide poisoning and overheating of the oven.
- **WARNING:** NEVER cover any slots, holes or passages in the oven bottom or cover an entire rack with materials such as aluminum foil. Doing so blocks airflow through the oven and may cause carbon monoxide poisoning. Aluminum foil linings may also trap heat, causing a fire hazard.
- **CAUTION:** Do not store items of interest to children in cabinets above a range or on the back guard of a range – children climbing on the range to reach items could be seriously injured.
- Do Not Leave Children Alone – Children should not be left alone or unattended in area where range is in use. They should never be allowed to sit or stand on any part of the range.
- Wear Proper Apparel – Loose-fitting or hanging garments should never be worn while using the range.
- User Servicing – Do not repair or replace any part of the range unless specifically recommended in the manual. All other servicing should be referred to a qualified technician.
- Storage in or on Range – Flammable materials should not be stored in an oven or near surface units.
- This appliance is not intended for storage.

READ AND SAVE THESE INSTRUCTIONS

IMPORTANT SAFETY INSTRUCTIONS

- Do Not Use Water on Grease Fires – Smother fire or flame or use dry chemical or foam-type extinguisher.
- Use Only Dry Potholders – Moist or damp potholders on hot surfaces may result in burns from steam. Do not let potholder touch hot heating elements. Do not use a towel or other bulky cloth.
- Never Leave Surface Units Unattended at High Heat Settings – Boilover causes smoking and greasy spillovers that may ignite.
- Glazed Cooking Utensils – Only certain types of glass, glass/ceramic, ceramic, earthenware, or other glazed utensils are suitable for range-top service without breaking due to the sudden change in temperature.
- Utensil Handles Should Be Turned Inward and Not Extend Over Adjacent Surface Units – To reduce the risk of burns, ignition of flammable materials, and spillage due to unintentional contact with the utensil, the handle of a utensil should be positioned so that it is turned inward, and does not extend over adjacent surface units.
- Disconnect power before servicing.
- Proper Installation – The appliance, when installed, must be electrically grounded in accordance with local codes, or in the absence of local codes, with the National Electrical Code, ANSI/NFPA 70 or the Canadian Electrical Code, CSA C22.1-02. In Canada, the appliance must be electrically grounded in accordance with Canadian Electrical Code. Be sure your appliance is properly installed and grounded by a qualified technician.
- Injuries may result from misuse of appliance doors or drawers such as stepping, leaning, or sitting on the doors or drawers.
- Maintenance – Keep range area clear and free from combustible materials, gasoline, and other flammable vapors and liquids.
- Do not let cooking grease or other flammable materials accumulate in or near the range. Grease in the oven or on the cooktop may ignite.
- Top burner flame size should be adjusted so it does not extend beyond the edge of the cooking utensil. This instruction is based on safety considerations.

READ AND SAVE THESE INSTRUCTIONS

IMPORTANT SAFETY INSTRUCTIONS

- Do not use replacement parts that have not been recommended by the manufacturer (e.g. parts made at home using a 3D printer).
- Clean Cooktop With Caution – If a wet sponge or cloth is used to wipe spills on a hot cooking area, be careful to avoid steam burn. Some cleaners can produce noxious fumes if applied to a hot surface.
- Use Care When Opening Door – Let hot air or steam escape before removing or replacing food.
- Do Not Heat Unopened Food Containers – Build-up of pressure may cause container to burst and result in injury.
- Keep Oven Vent Ducts Unobstructed.
- Never broil with door open. Open-door broiling is not permitted due to overheating of control knobs.
- Placement of Oven Racks – Always place oven racks in desired location while oven is cool. If rack must be moved while oven is hot, do not let potholder contact hot heating element in oven.
- Care must be taken to prevent aluminum foil and meat probes from contacting heating elements.
- **DO NOT TOUCH HEATING ELEMENTS OR INTERIOR SURFACES OF OVEN** – Heating elements may be hot even though they are dark in color. Interior surfaces of an oven become hot enough to cause burns. During and after use, do not touch, or let clothing or other flammable materials contact heating elements or interior surfaces of oven until they have had sufficient time to cool. Other surfaces of the appliance may become hot enough to cause burns – among these surfaces are cooktop, burners, grates, oven vent openings and surfaces near these openings, oven doors, windows of oven doors, and crevices around the oven doors.
- Top burner flame size should be adjusted so it does not extend beyond the edge of the cooking utensil.
- Have the installer show you the location of the range gas shut-off valve and how to turn it off if necessary.

READ AND SAVE THESE INSTRUCTIONS

IMPORTANT SAFETY INSTRUCTIONS

- Proper Disposal of Your Appliance – Dispose of or recycle your appliance in accordance with Federal and Local Regulations. Contact your local authorities for the environmentally safe disposal or recycling of your appliance.

For units with ventilating hood –

- Clean Ventilating Hoods Frequently – Grease should not be allowed to accumulate on hood or filter.
- When flambé cooking under the vent hood, turn the fan on.

For self-cleaning ranges –

- Do Not Clean Door Gasket – The door gasket is essential for a good seal. Care should be taken not to rub, damage, or move the gasket.
- Do Not Use Oven Cleaners – No commercial oven cleaner or oven liner protective coating of any kind should be used in or around any part of the oven.
- Clean Only Parts Listed in Manual.
- Before Self-Cleaning the Oven – Remove broiler pan and other utensils. Wipe off all excessive spillage before initiating the cleaning cycle.

READ AND SAVE THESE INSTRUCTIONS

OVERVIEW

RANGE LAYOUT

This illustration covers several different models. The range you have purchased may have some or all of the items listed. The locations and appearances of the features shown here may not match those of your model.

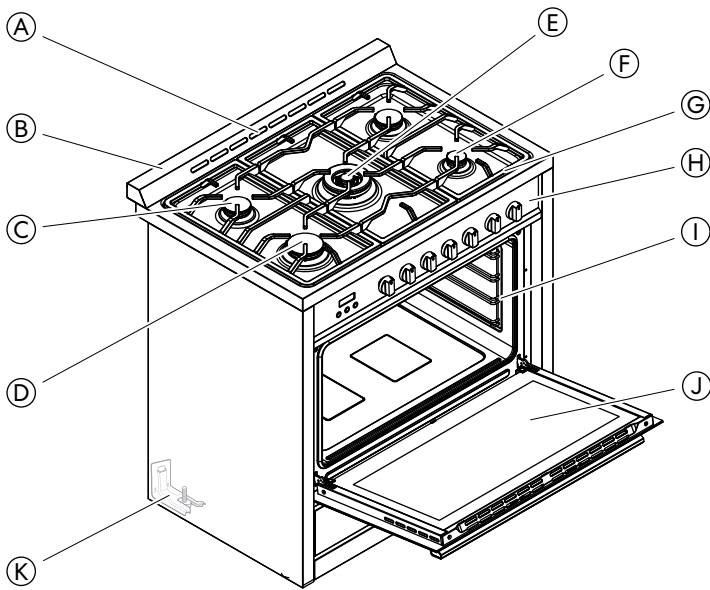

- A.** Oven vent
- B.** Backsplash
- C.** Semi-rapid burner
- D.** Rapid burner
- E.** Triple ring burner
- F.** Auxiliary burner
- G.** Surface burner grate
- H.** Control panel
- I.** Oven rack positions
- J.** Oven door window
- K.** Anti-tip bracket
COS-965AGC(-BK)(-BKS) only

WHAT'S INCLUDED

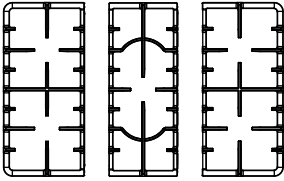

Surface burner grates (3)

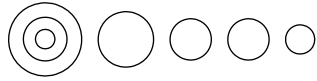

Surface burners and caps (5)

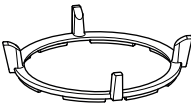

Wok grate

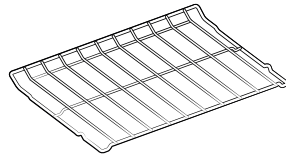

Oven racks (2)

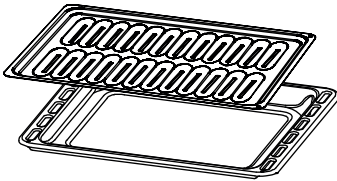

2-Piece broiler pan

NOTE:

- To purchase these replacement parts or any other accessories, please visit www.cosmoappliances.com or reference the contact information at the end of this manual.

CONTROL PANEL

The appearance of the control panel and the knobs may vary from what is shown in the manual.

COS-965AGC(-BK)(-BKS) / COS-965AGFC(-BK)(-BKS)

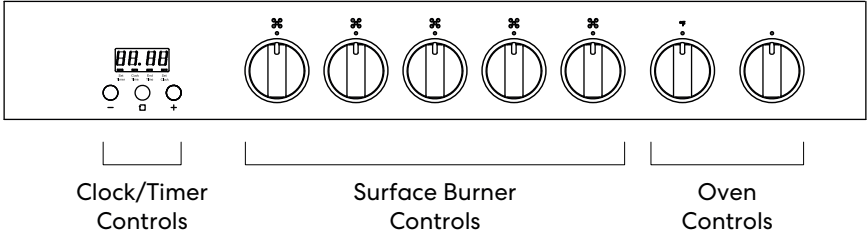

FEATURES

CLOCK & TIMER

SETTING THE CLOCK AND TIMER

IMPORTANT: Clock must be set in order for the timed oven functions to work.

Your model has a digital display clock with 3 control buttons.



NOTE:

- In the event of a power failure, the clock time set will be lost. When the power is returned, clock must be set again.

TO SET THE TIME OF DAY

When the power is connected or after a power outage, the screen will display 12.00 and the indicator bar above "Set Clock" will blink.





1. If the clock was previously set, press the  function button repeatedly until the indicator bar blinks above "Set Clock".
2. Press or hold the + or - button to adjust the clock. The clock will be confirmed automatically if you leave the correct time there for 5 seconds without pressing any buttons, and the indicator bar will become solid. You may also press the  function button to confirm the clock manually while the indicator bar is blinking.

TO SET THE TIMER

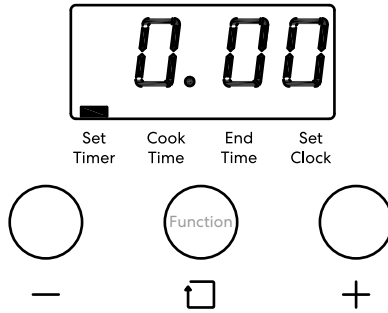
The digital countdown timer can be set up to 11 hours and 59 minutes maximum.



1. Press the  function button repeatedly until the indicator bar blinks above "Set Timer".
2. Press or hold the + or - button to set the length of time, then press the  function button or wait for 5 seconds to confirm.

Once confirmed, the current time will be shown and the countdown will begin. When the countdown is finished, press any button to stop the beeping.

To view and modify the countdown time remaining, press the  function button once to select "Set Timer" again and use the + or - button to adjust the current timer as needed.

To cancel the timer, follow the steps above to set the length of time to 0.00.

NOTE:

- When adjusting the time, idling for 5 seconds without pressing any buttons will automatically confirm the current time on the display.

TIMED COOKING

WARNING

FOOD POISONING HAZARD

- Do not let food sit in oven more than one hour before or after cooking. Doing so can result in food poisoning or sickness.
- Foods that can easily spoil such as milk, eggs, fish, meat or poultry, should be chilled in the refrigerator first. Even when chilled, they should not stand in the oven for more than 1 hour before cooking begins, and should be removed promptly when finished cooking.

WARNING

- Reset all controls to the OFF position after using a programmable timing operation. No attempt should be made to operate the appliance during power failure.

- **Set Cook Time only:**

Cook for the set length of time from now, then shut off the oven automatically.

- **Set End Time only:**



Shut off the oven automatically at the set time of day.

NOTE:

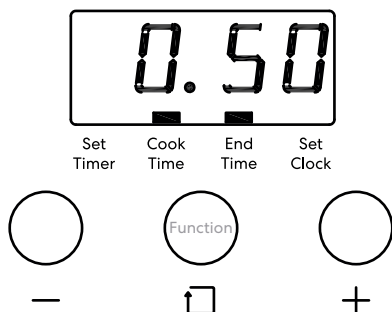

- Clock must be set in order for the timed oven functions to work.
- Only one of Cook Time and End Time can be used at a time.



TO SET THE COOK TIME

1. Press the  function button until the bar flashes above "Cook Time".
2. Use the + or – button to set the length of cooking time (maximum of 10 hours).
3. Press the  function button or wait for 5 seconds to confirm.

TO SET THE END TIME

1. Press the  function button until the bar flashes above "End Time".
2. Use the + or – button to set the shut off time of day.
3. Press the  function button or wait for 5 seconds to confirm.

SETTING THE COOKING METHODS

The appearance of the knobs may vary from what is shown in the manual.

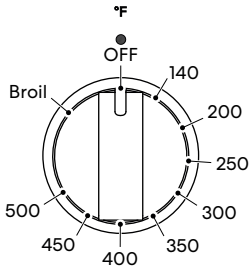

Thermostat knob (°F)

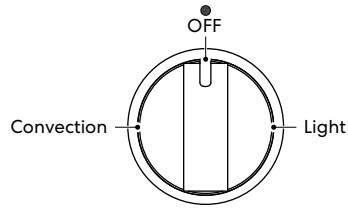

Cooking-mode knob

Thermostat Knob

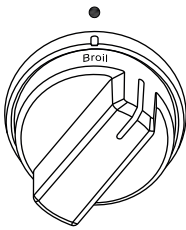

Broil position

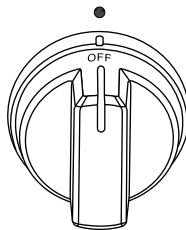

OFF position

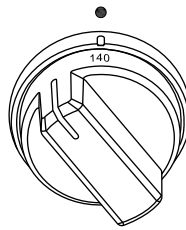

Bake (140°F)
position

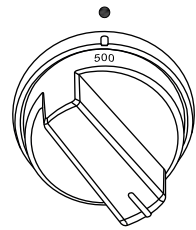



Bake (500°F)
position



1. After setting the cook time or end time, turn the oven thermostat and cooking-mode knobs to set the desired temperature and cooking mode.
2. The oven will automatically turn on or shut off according to the cook time or end time set.
3. When the shut off time is reached, press any button to stop the beeping and turn the oven knobs to the OFF position.

Example:

Start/Continue baking at 350°F for 50 minutes and finish cooking at 6:00.

1. Press the  function button repeatedly until the indicator bar blink above "Cook Time". Use the + or – button to set the length of cooking time to 0.50, then press the  function button or wait for 5 seconds to confirm.

OR

Press the  function button repeatedly until the indicator bar blink above "End Time". Use the + or – button to set the shut off time of day to 6.00, then press the  function button or wait for 5 seconds to confirm.

2. Turn/Keep the thermostat knob at 350°F. Once the clock time is returned on the display, the indicator bar above "Cook Time" or "End Time" will be blinking, indicating a schedule is set.
3. At 6:00 when the cooking is finished, the oven will shut off automatically. Press any button to stop the beeping, and turn the oven knobs to the OFF position.

OPERATION

GAS SURFACE BURNERS

BEFORE USING THE GAS SURFACE BURNERS

Read all instructions before using.

WARNING

- Make sure all burners are in their correct locations and fully assembled before attempting to operate any burner.
- Never leave the surface burners on unattended. Boilovers may cause smoke and greasy spillovers that may ignite.
- Do not use aluminum foil to line or cover the cooktop, grates, or any other part of the cooktop. Doing so may result in carbon monoxide poisoning, overheating of the cooktop surfaces, or fire.
- Use the proper pan size. Do not use pans that are unstable or that can be easily tipped. Select cookware with flat bottoms large enough to cover burner grates.
- To avoid spillovers, make sure the cookware is large enough to contain the food properly. This will both save cleaning time and prevent hazardous accumulations of food, since heavy spattering or spillovers left on the range can ignite.

CAUTION

- Control the top burner flame size so it does not extend beyond the edge of the cookware. Excessive flame is hazardous.
- Do not operate the burner for an extended period of time without cookware on the grate. The finish on the grate may discolor or chip without cookware to absorb the heat.
- Do not attempt to disassemble any burner while another burner is on. Damage to the product may occur.
- Be sure the burners and grates are cool before you place your hand, a pot holder or cleaning materials on them.

IMPORTANT:

- This appliance shall be installed in accordance with the regulations in force and only used in a well-ventilated space.
- The use of a gas-cooking appliance results in the production of heat and moisture in the room in which it is installed. Ensure that the kitchen is well ventilated: keep natural ventilation holes open or install a mechanical ventilation device (mechanical extractor hood).
- Prolonged intensive use of the appliance may call for additional ventilation, for example opening of a window, or more effective ventilation, for example increasing the level of mechanical ventilation where present.

USING THE GAS SURFACE BURNERS

Lighting a Surface Burner

1. Select a burner and find its control knob.
2. Push the control knob in and turn it to the IGNITE position. The electric spark ignition system will make a clicking noise.

NOTE:

- When one burner is turned to IGNITE, all burners will spark. Sparking will continue as long as the knob remains at IGNITE.

3. Once gas is ignited, turn the control knob to adjust the flame size.

4. To turn off a burner, turn the control knob to the OFF position.

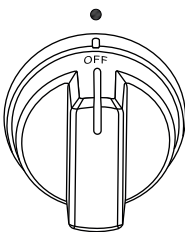

OFF position

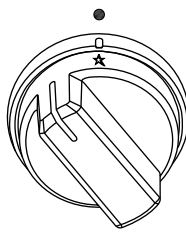

IGNITE position

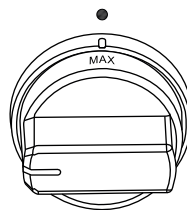

MAX position

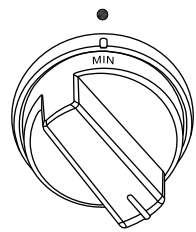

MIN position

NOTE:

- The electric igniter must not be actuated for longer than 15 seconds. Should the burner not light, or should the burner be unintentionally turned off, immediately close the burner, and wait at least 1 minute before repeating. Once ignited, adjust the flame as desired.
- For models with a flame failure safety device - Once the flame is lit, hold the knob depressed for about 3-4 seconds until the device keeps the burner automatically lit. If the burner fails to ignite, wait one minute for the gas to dissipate before attempting to reignite. In the case of unintentional flame extinguishing, the safety valve intervenes by shutting off the gas to the burners.

Selecting a Flame Size

Watch the flame, not the control knob, as you reduce heat. Match the flame size on a gas burner to the cookware being used for fastest heating.

NOTE:

- Never let the flames extend up the sides of the cookware. Flames larger than the bottom of the cookware will not heat faster and may be hazardous.

In Case of Power Failure

In case of a power failure, you can light the gas surface burners on your range with a match. Surface burners in use when an electrical power failure occurs will continue to operate normally.

1. Using extreme caution, hold a lit match to the burner
2. Push in the control knob, then turn the control knob to the MIN position.
3. Once gas is ignited, turn the control knob to adjust the flame size.

USING THE WOK GRATE

Use the included wok grate to support a 12" to 14" round-bottomed wok.

1. Place the wok grate on top of the surface burner grate, aligning the notches on the wok grate with the surface burner grate's fingers.

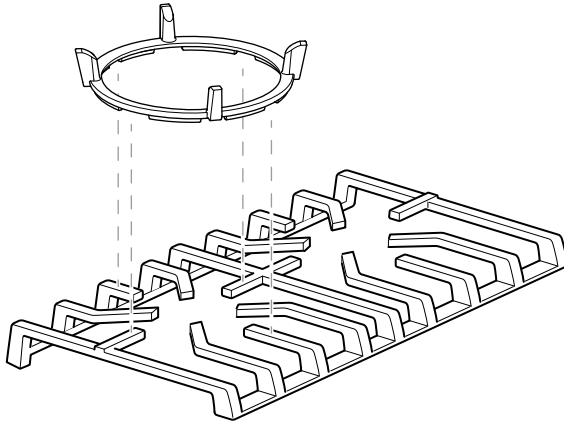

NOTE:

- Turn off all burners and allow wok grate, burner grates, and cooktop to cool before installing or removing wok grate.
- Make sure the wok grate is stable and the wok rests firmly on the wok grate.
- Do not use a wok that is the wrong size to fit securely in the wok grate.
- For best performance, place the wok grate over the larger burner.
- Do not use the wok grate with cookware other than a wok.
- Clean the wok grate with hot, soapy water. Do not use oven cleaners, steel wool, or abrasive cleansers. Do not clean with the self-clean mode.

USING THE PROPER COOKWARE

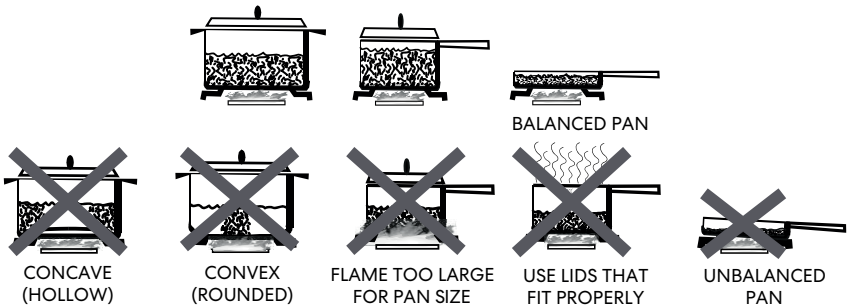

Match Pan Diameter to Flame Size

The flame should be the same size as the bottom of the pan or smaller. Do not use small pans with high flame settings as the flames can lick up the sides of the pan. Oversized pans that span two burners are placed front to rear, not side to side.

Use Balanced Pans

Pans must sit level on the cooktop grate without rocking. Center the pan over the burner.

Use a Lid That Fits Properly

A well-fitting lid helps shorten the cooking time. Flat, heavy bottom pans provide even heat and stability.

Cookware Size Table

Burner	Min Saucepan Size	Max Saucepan Size
Auxiliary (Small)	3.5" (9.0 cm)	6.3" (16 cm)
Semi-rapid (Medium)	5.1" (13 cm)	7.1" (18 cm)
Rapid (Large)	5.9" (15 cm)	10.2" (26 cm)
Triple ring (X-Large)	8.3" (21 cm)	10.2" (26 cm)

OVEN

BEFORE USING THE OVEN

Read the instructions for each feature and cooking mode in this manual carefully before using the oven.

CAUTION

- Do not use any type of foil or oven liner to cover the oven bottom. These items can trap heat or melt, resulting in damage to the product and risk of shock, smoke or fire. Damage from improper use of these items is not covered by the product warranty.
- Foil may be used to catch spills by placing a sheet on a lower rack, several inches below the food. Do not use more foil than necessary and never entirely cover an oven rack with aluminum foil. Keep foil at least 1-1/2" (3.8 cm) from oven walls to prevent poor heat circulation.
- Do not cover the slotted grid of the 2-piece broiler pan with aluminum foil. This will catch the grease and could cause fire.
- Do not use plastic wrap or wax paper in the oven.
- Do not place food, water, ice, or any dish or tray directly on the oven floor, as this will irreversibly damage the enamel surface.
- Do not block, touch or place items around the oven vent during cooking. Your oven is vented through ducts at the center above the burner grate. Do not block the oven vent when cooking to allow for proper air flow.
- In case of power failure, do not use the oven. The oven and broiler cannot be used during a power outage. If the oven is in use when a power failure occurs, the oven burner shuts off and cannot be re-lit until power is restored. Once power is restored, you will need to reset the oven cooking mode.
- Do not attempt to operate the electric ignition during an electrical power failure.
- As the oven heats up, the heated air in the oven may cause condensation to appear on the oven door glass. These water drops are harmless and will evaporate as the oven continues to heat up.
- An air curtain or other overhead range hood, which operates by blowing a downward airflow onto a range shall not be used in conjunction with a gas range.

WARNING

FOOD POISONING HAZARD

- Do not let food sit in oven more than one hour before or after cooking. Doing so can result in food poisoning or sickness.
- Foods that can easily spoil such as milk, eggs, fish, meat or poultry, should be chilled in the refrigerator first. Even when chilled, they should not stand in the oven for more than 1 hour before cooking begins, and should be removed promptly when finished cooking.

IMPORTANT: Clock must be set in order for the oven to work. Your model has a digital display clock with 3 control buttons. See "Setting the Clock and Timer" section.

NOTE:

- Because the oven temperature cycles, an oven thermometer placed in the oven cavity may not show the same set temperature on the oven.

BEFORE USING THE OVEN FOR THE FIRST TIME

Start the oven in BAKE mode at the highest available temperature setting. Allow oven to run for 1 hour to remove any dust or impurities. There will be a distinctive odor - this is normal. Ensure your kitchen is well ventilated during this conditioning period.

OVEN VENT

Areas near the vent may become hot during operation and may cause burns. Avoid placing plastics near the vent as heat may distort or melt the plastic.

Do not block the vents (air openings) of the range. They provide the air inlet and outlet that are necessary for the range to keep cool and operate properly with correct combustion.

It is normal for steam to be visible when cooking foods with high moisture content.

OVEN DOOR

To avoid oven door glass breakage:

- Do not close the oven door if the racks are not fully inserted into the oven cavity or if bakeware extends past the front edge of an oven rack.
- Do not set objects on the glass surface of the oven door.
- Do not hit glass surfaces with bakeware or other objects.
- Do not wipe down glass surfaces until the oven has completely cooled.

USING OVEN RACKS

The racks have a turned-up back edge that prevents them from being pulled out of the oven cavity.

CAUTION

- Replace oven racks before turning the oven on to prevent burns.
- Do not cover the racks with aluminum foil, or any other material, or place anything on the bottom of the oven. Doing so will result in poor baking and may damage the oven bottom.
- Only arrange oven racks when the oven is cool.

Removing Racks

1. Pull the rack straight out until it stops.
2. Lift up the front of the rack and pull it out.

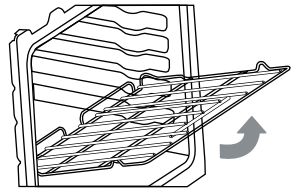

Replacing Racks

1. Place the end of the rack on the support.
2. Tilt the front end up and push the rack in.

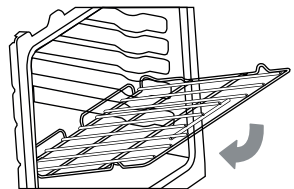

Rack Positions

For best cooking results, adjust rack so food is placed at the center of the oven. For most foods this will be rack position #2 or #3. For larger foods like roasts and turkey, move the rack position down to #1 or #2 to keep the food centered in the oven.

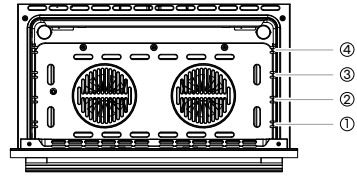

When using multiple racks simultaneously, try to space the food out around the oven center (rack position #1 and #3 or #2 and #4 for two racks).

Broiling performs best with the food close to the broil burner - typically rack position #4 or #5.

PREHEATING

Preheating is generally desirable, although not absolutely necessary in all circumstances. Some foods are more robust and may have acceptable results without preheating. These foods include large pieces of meat (whole roasts, hams, or poultry) where the total cooking time is much longer than the time required to preheat. These foods also include frozen potato products and frozen processed dinners that, by their nature and design, are more robust to baking variations. More delicate foods, such as breads (including cakes, cookies, pastries, and pizzas), desserts, soufflés, etc. will likely not have acceptable results without proper preheating.

OVEN CONTROLS

The Thermostat and Cooking-mode knobs are used together to select Oven Modes. The appearance of the knobs may vary from what is shown in the manual.

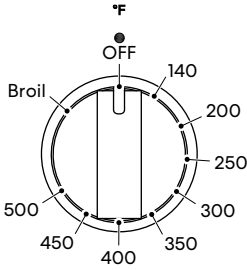

Thermostat knob (°F)

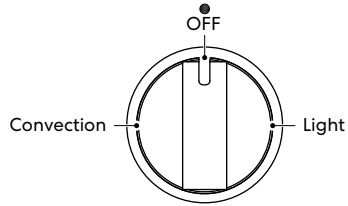

Cooking-mode knob

THERMOSTAT KNOB

Push in on the Thermostat knob, and then turn the knob to any baking temperature or broil to automatically ignite the bake burner or the broil burner.

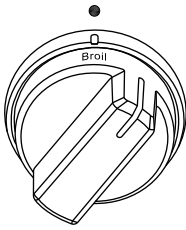

Broil position

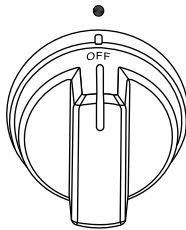

OFF position

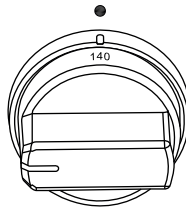

Bake (140°F)
position

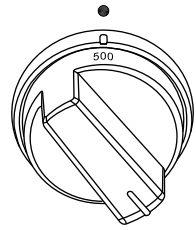

Bake (500°F)
position

COOKING-MODE KNOB

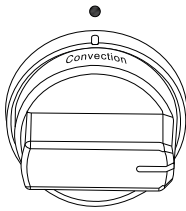

Convection
position

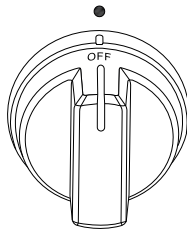

OFF position

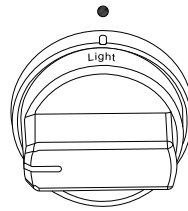

Light position

Conv Fan (Convection Fan)

The Convection Fan mode uses air movement from the fan to improve heat distribution and enhance cooking evenness within the oven. Cooking times may be slightly longer for multiple racks than what would be expected for a single rack.

NOTE:

- The convection fan turns on for Bake mode only.

Light

The Light mode turns on oven light inside the oven.

For video instructions on how to
use your range, scan QR Code:



BAKE

THERMOSTAT RANGE: 140°F (60°C) TO MAX 500°F (260°C)

The Bake mode uses heat from the lower element to cook food. When using this mode to prepare baked goods such as cakes, cookies and pastries, always preheat the oven first and place food centrally near the middle racks.

Setting the Bake Mode (Example: Set Bake at 375°F.)

1. Adjust oven rack levels as needed.
2. Turn the thermostat knob to select **375°F**. The oven turns on and starts preheating.

NOTE:

- Once the oven reaches the set temperature, the oven pauses heating temporarily. The oven heating cycle will automatically resume to maintain the set temperature.

3. Place the food in the oven after preheating.
4. Turn the thermostat knob to the **OFF** position when cooking is finished, and remove the food from the oven.

NOTE:

- Baking time and temperature will vary depending on the characteristics, size, and shape of the baking pan used.
- Check for food doneness at the minimum recipe time.
- Use metal bakeware (with or without a nonstick finish), heatproof glass-ceramic, ceramic or other bakeware recommended for oven use.
- Dark metal pans or nonstick coatings will cook food faster with more browning. Insulated bakeware will slightly lengthen the cooking time for most foods.

BROIL

THERMOSTAT RANGE: Broil

The Broil mode uses intense heat from the upper element to sear foods. Ideal for toasting, melting cheese, browning and searing surface. Food should be placed near the upper racks, and should not be cooked for too long on each side of the food. It is not necessary to preheat when using this mode.

Setting the Broil Mode

1. Adjust oven rack levels as needed and place the food in the oven.
2. Turn the thermostat knob to select **BROIL**. The oven turns on and starts preheating.
3. Place the food in the oven after preheating for about 5 minutes.
4. Turn the thermostat knob to the **OFF** position when cooking is finished, and remove the food from the oven.

NOTE:

- The broil burner is very powerful. Follow recipe directions and monitor food closely to reduce risk of burning food.
- Always use a broiler pan and grid for excess fat and grease drainage. This will help to reduce splatter, smoke, and flare-ups.
- Do not use a broiler pan without a grid. Oil can cause a grease fire.
- Do not cover the grid and broiler pan with aluminum foil. Doing so will cause a fire.

CONVECTION BAKE

THERMOSTAT RANGE: 140°F (60°C) TO MAX 500°F (260°C)

The Convection Bake mode uses heat from the lower heating element and hot air movement from the convection fan to enhance cooking efficiency and evenness across multiple racks. Always preheat the oven first. Baking times may be slightly longer for multiple racks than what would be expected for a single rack.

Setting the Convection Bake Mode

(Example: Set Convection Bake at 375°F.)

1. Adjust oven rack levels as needed.
2. Turn the thermostat knob to select **375°F**, and turn the cooking-mode knob to **Convection**. The oven turns on and starts preheating.

NOTE:

- Once the oven reaches the set temperature, the oven pauses heating temporarily. The oven heating cycle will automatically resume to maintain the set temperature.

3. Place the food in the oven after preheating.
4. Turn the cooking-mode knob and the thermostat knob to the **OFF** position when cooking is finished, and remove the food from the oven.

NOTE:

- The oven fan runs while convection baking.
- Use Convection Bake for faster and more even multiple-rack cooking of pastries, cookies, muffins, biscuits, and breads of all kinds.
- Place the oven racks in positions suggested in the "Tips and Techniques" section.
- Bake cookies and biscuits on pans with no sides or very low sides to allow heated air to circulate around the food. Food baked on pans with a dark finish will cook faster.

TIPS AND TECHNIQUES

BAKE

Baking is cooking with heated air. Both upper and lower elements in the oven are used to heat the air but no fan is used to circulate the heat.

Follow the recipe or convenience food directions for baking temperature, time and rack position. Baking time will vary with the temperature of ingredients and the size, shape and finish of the baking utensil.

- For best results, bake food on a single rack with at least 1" - 1½" (2.5 - 3 cm) space between utensils and oven walls.
- Use one rack when selecting the bake mode.
- Check for doneness at the minimum time.
- Use metal bake ware (with or without a non-stick finish), heatproof glass, glass-ceramic, pottery or other utensils suitable for the oven.
- When using heatproof glass, reduce temperature by 25°F (15°C) from recommended temperature.
- Use baking sheets with or without sides or jelly roll pans.
- Dark metal pans or nonstick coatings will cook faster with more browning. Insulated bake ware will slightly lengthen the cooking time for most foods.
- Do not use aluminum foil or disposable aluminum trays to line any part of the oven. Foil is an excellent heat insulator and heat will be trapped beneath it. This will alter the cooking performance and can damage the finish of the oven.
- Avoid using the opened door as a shelf to place pans.
- See Troubleshooting for tips to solve baking/oven problems.

Bake Chart

FOOD ITEM	RACK POSITION	BAKE TEMP. SETTING °F (°C) (PREHEATED OVEN)	TIME (MIN)
Cake			
Cupcakes	3	350 (175)	19-22
Bundt Cake	2	350 (175)	40-45
Angel Food	2	350 (175)	35-39
Pie			
2 crust, fresh, 9"	3	375-400 (190-205)	45-50
2 crust, frozen fruit, 9"	3	375 (190)	68-78
Cookies			
Sugar	3	350-375 (175-190)	8-10
Chocolate Chip	3	350-375 (175-190)	8-13
Brownies	3	350 (175)	29-36
Breads			
Yeast bread loaf, 9x5	2	375 (190)	18-22
Yeast rolls	2	375-400 (190-205)	12-15
Biscuits	3	375-400 (190-205)	7-9
Muffins	2	425 (220)	15-19
Pizza			
Frozen	3	400-450 (205-235)	23-26
Fresh	3	475 (246)	15-18

BROIL

The Broil mode uses intense heat from the upper heating element to sear foods. The size, weight, thickness, starting temperature, and your preference of doneness will affect broiling times.

- For best results when broiling, use a pan designed for broiling.
- Preheat the oven for about 5 minutes before placing food in the oven.

Broil Chart

FOOD ITEM	RACK POSITION	INTERNAL FOOD TEMP. °F (°C)	TIME SIDE 1 (MIN)	TIME SIDE 2 (MIN)
Beef				
Steak (¾"-1")				
Medium Rare	5	145 (65)	5-7	4-6
Medium	5	160 (71)	6-8	5-7
Well Done	5	170 (77)	8-10	7-9
Hamburgers (¾"-1")				
Medium	4	160 (71)	8-11	6-9
Well Done	4	170 (77)	10-13	8-10
Poultry				
Breast (bone-in)	4	170 (77)	10-12	8-10
Thigh (very well done)	4	180 (82)	28-30	13-15
Pork				
Pork Chops (1")	5	160 (71)	7-9	5-7
Sausage (fresh)	5	160 (71)	5-7	3-5
Ham Slice (½")	5	160 (71)	4-6	3-5
Seafood				
Fish Filets (1" buttered)	4	Cook until opaque & flakes easily with fork	10-14	Do not turn
Lamb				
Chops (1")				
Medium Rare	5	145 (63)	5-7	4-6
Medium	5	160 (71)	6-8	4-6
Well Done	5	170 (77)	7-9	5-7
Bread				
Garlic Bread, (1" slices)	4		2-3	
Garlic Bread, (1" slices)	3		4-6	

CONVECTION BAKE

The Convection Bake mode uses heat from the lower heating element primarily and the upper heating element and hot air movement from the convection fan to enhance cooking efficiency and evenness across multiple racks. Reduce recipe baking temperatures by 25°F (15°C).

- For best results, foods should be cooked uncovered, in low-sided pans to take advantage of the forced air circulation. Use shiny aluminum pans for best results unless otherwise specified.
- Heatproof glass or ceramic can be used. Reduce temperature by another 25°F (15°C) when using heatproof glass dishes for a total reduction of 50°F (30°C).
- Dark metal pans may be used. Note that food may brown faster when using dark metal bakeware.
- The number of racks used is determined by the height of the food to be cooked.
- Baked items, for the most part, cook extremely well in convection. Don't try to convert recipes such as custards, quiches, pumpkin pie, or cheesecakes, which do not benefit from the convection-heating process. Use the regular Bake mode for these foods.
- Multiple rack cooking for oven meals is mostly done on rack positions 1, 2, 3, and 4. All four racks can be used for cookies, biscuits and appetizers.
 - 2 Rack baking: Use positions 2 and 3 or 1 and 2.
 - 3 rack baking: Use positions 1, 2, and 3.
 - When baking four cake layers at the same time, stagger pans so that one pan is not directly above another. For best results, place cakes on front of upper rack and back of lower rack (See graphic at right). Allow 1" - 1½" (2.5 - 3 cm) air space around pans.

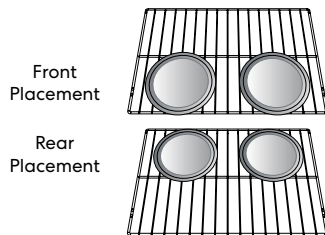
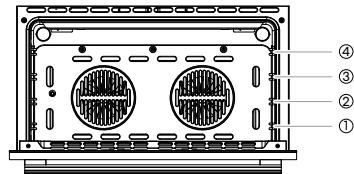

- Reduce the temperature and cooking time if necessary. It may take some trial and error to achieve a perfect result. Keep track of your technique for the next time you want to prepare the recipe using convection.
- See Troubleshooting for tips on solving baking/oven problems.

Convection Bake Chart

Reduce standard recipe temperature by 25°F (15°C) for Convection Bake. Temperatures have been reduced in this chart.

FOOD ITEM	RACK POSITION	CONV BAKE TEMP. SETTING °F (°C) (PREHEATED OVEN)	TIME (MIN)
Cake			
Cupcakes	3	325 (160)	20-22
Bundt Cake	2	325 (160)	43-50
Angel Food	2	325 (160)	43-47
Pie			
2 crust, fresh, 9"	3	350-400 (175-205)	40-52
2 crust, frozen fruit, 9"	3	350 (175)	68-78
Cookies			
Sugar	3	325-350 (160-175)	9-12
Chocolate Chip	3	325-350 (160-175)	8-13
Brownies	3	325 (160)	29-36
Breads			
Yeast bread loaf, 9x5	2	350 (175)	18-22
Yeast rolls	2	350-375 (175-190)	12-15
Biscuits	3	375 (190)	8-10
Muffins	2	400 (205)	17-21
Pizza			
Frozen	3	375-425 (190-220)	23-26
Fresh	3	450 (232)	15-18

RANGE CARE

CLEANING

IMPORTANT: Before cleaning, make sure all controls are off and the oven and cooktop are cool. Always follow label instructions on cleaning products. Soap, water and a soft cloth or sponge are suggested first unless otherwise noted. Do not use abrasive cleaning products.

NOTE:

- Do not clean the oven door gasket. The material of the gasket cannot withstand abrasion. It is essential for the gasket to remain intact. If you notice it becoming worn or frayed, replace it.

PORCELAIN-COATED GRATES AND CAPS

- Clean as soon as cooktop, grates and caps are cool.
- Food spills containing acids, such as vinegar and tomato, should be cleaned as soon as the cooktop grates and caps are cool. These spills may affect the finish.
- To avoid chipping, do not bang grates and caps against each other or hard surfaces such as cast iron cookware.
- Do not reassemble caps on burners while wet.

Cleaning Method:

- Nonabrasive plastic scrubbing pad and mildly abrasive cleanser.

BURNER SPREADER

Cleaning Method:

- Wash the burner spreader frequently with boiling water and detergent to remove any deposits which could block the flame outlet.
- Before reinstalling, dry the burner spreader thoroughly so the burner will ignite properly.

EXTERIOR PORCELAIN ENAMEL SURFACES

- Food spills containing acids, such as vinegar and tomato, should be cleaned as soon as the entire appliance is cool. These spills may affect the finish.

Cleaning Method:

- Glass cleaner, mild liquid cleaner or nonabrasive scrubbing pad: Gently clean around the model and serial number plate because scrubbing may remove numbers.

EXTERIOR STAINLESS STEEL

- Rub in direction of grain to avoid damaging.

Cleaning Methods:

- Liquid detergent or all-purpose cleaner: Rinse well with clean water and dry with soft, lint-free cloth.
- Stainless Steel Cleaner and Polish. Vinegar for hard water spots.

NOTE:

- Do not use soap-filled scouring pads, abrasive cleaners, Cooktop Polishing Cream, steel-wool pads, gritty washcloths or some paper towels. Damage may occur, even with one-time or limited use.

CONTROL PANEL

Cleaning Method:

- Glass cleaner and soft cloth or sponge: Apply glass cleaner to soft cloth or sponge, not directly on panel.

NOTE:

- Do not use abrasive cleaners, steel-wool pads, gritty washcloths or some paper towels. Damage may occur.

CONTROL KNOBS

- Pull knobs straight away from control panel to remove.
- When replacing knobs, make sure knobs are in the Off position.

Cleaning Method:

- Soap and water or dishwasher.

NOTE:

- Do not use steel wool, abrasive cleansers or oven cleaner. Do not soak knobs.

OVEN DOOR EXTERIOR

Cleaning Method:

- Glass cleaner and paper towels or nonabrasive plastic scrubbing pad: Apply glass cleaner to soft cloth or sponge, not directly on panel.

OVEN CAVITY

- Food spills should be cleaned when oven cools. At high temperatures, foods react with porcelain, so staining, etching, pitting or faint white spots can result.

Cleaning Method:

- Mild detergent and warm water.

NOTE:

- Do not use oven cleaners.

OVEN RACKS AND ROASTING RACKS

Cleaning Method:

- Steel-wool pad

2-PIECE BAKING TRAY OR BROILER PAN

Cleaning Method:

- Mildly abrasive cleanser: Scrub with wet scouring pad.
- Solution of ½ cup (125 mL) ammonia to 1 gal. (3.75 L) water: Soak for 20 minutes, and then scrub with scouring or steel-wool pad.
- Oven cleaner: Follow product label instructions.

Porcelain enamel only, not chrome

- Dishwasher

TROUBLESHOOTING

First try the solutions suggested here to possibly avoid the cost of a service call.

BAKING PROBLEMS

With any oven setting poor results can occur for many reasons other than a malfunction of the oven. Check the chart below for causes of the most common problems. Since the size, shape and material of baking utensils directly affect the baking results, the best solution may be to replace old baking utensils that have darkened and warped with age and use.

PROBLEM	CAUSE
Food browns unevenly	<ul style="list-style-type: none">• Oven not preheated• Aluminum foil on oven rack or oven bottom• Baking utensil too large for recipe• Pans touching each other or oven walls
Food too brown on bottom	<ul style="list-style-type: none">• Oven not preheated• Using glass, dull or darkened metal pans• Incorrect rack position• Pans touching each other or oven walls
Food is dry or has shrunk excessively	<ul style="list-style-type: none">• Oven temperature too high• Baking time too long• Oven door opened frequently• Pan size too large
Food is baking or roasting too slowly	<ul style="list-style-type: none">• Oven temperature too low• Oven not preheated• Oven door opened frequently• Tightly sealed with aluminum foil• Pan size too small

PROBLEM	CAUSE
Pie crusts do not brown on bottom or crust is soggy	<ul style="list-style-type: none"> • Baking time not long enough • Using shiny steel pans • Incorrect rack position • Oven temperature is too low
Cakes pale, flat and may not be done inside	<ul style="list-style-type: none"> • Oven temperature too low • Incorrect baking time • Cake tested too soon • Oven door opened too often • Pan size may be too large
Cakes high in middle with crack on top	<ul style="list-style-type: none"> • Oven temperature too high • Baking time too long • Pans touching each other or oven walls • Incorrect rack position • Pan size too small
Pie crust edges too brown	<ul style="list-style-type: none"> • Oven temperature too high • Edges of crust too thin

COOKTOP PROBLEMS

PROBLEM	POSSIBLE CAUSE	SOLUTION
Burner will not ignite	There is no power to the range.	Make sure electrical plug is plugged into a live, properly grounded outlet. Replace the fuse or reset the circuit breaker.
Burner will not operate	First time use. Air still in the gas line.	Turn on any one of the surface burner knobs to release air from the gas lines.
	Control knob is not set correctly.	Push in knob before turning to a setting.
	The burner port is clogged.	Clean burner port opening using a stiff, nylon toothbrush or a straightened paper clip.

PROBLEM	POSSIBLE CAUSE	SOLUTION
Burner Flames are uneven, yellow and/ or noisy	Burner port(s) are clogged.	Clean burner port opening using a stiff, nylon toothbrush or a straightened paper clip.
	Burner caps are not positioned properly.	Place burner caps so that the alignment pins are properly aligned with the slots.
	Propane gas is being used.	The range should be converted to LP gas by a qualified technician.
Burner flame is too high or too low	Cooktop gas supply is not correct.	Ensure the range is set for the correct gas type. It is factory set for natural gas. If connecting to LP gas, the burners should be converted to LP gas with the orifice kit supplied and the pressure regulator converted to the LP gas setting by a qualified technician.
	The gas pressure is not correct.	Make sure the pressure regulator is installed correctly and the gas line pressure is correct. See Installation Instructions.
Burner makes popping noises	The burner is wet.	Allow the burner to dry before using.
	The burner cap or gas spreader is not positioned correctly.	Place burner caps so that the alignment pins are properly aligned with the slots.
Excessive heat around cookware on cooktop	The cookware is not the proper size for the burner.	Use cookware with a bottom surface approximately the same size as the cooking area and burner. Cookware should not extend more than 1" (2.5 cm) outside the cooking area. Adjust the flame so that it does not come up around the cookware.
Cooking results are not what expected	Using incorrect cookware.	See the "Using the Proper Cookware" section.
	The control knob is not set to the proper heat level.	See the "Using the Gas Surface Burners" section.

OVEN PROBLEMS

PROBLEM	POSSIBLE CAUSE	SOLUTION
Oven is not heating	No power to the range.	Check the circuit breaker or fuse box to your house. Make sure there is proper electrical power to the oven.
	Oven control not turned on.	Make sure the oven temperature has been selected.
Oven is not cooking evenly	Not using the correct bake ware or oven rack position.	Refer to cook charts for recommended rack position. Always reduce recipe temperature by 25 °F (15 °C) when baking with Convention Bake mode.
Oven display stays Off	Power interruption.	Turn off power at the main power supply (fuse or breaker box). Turn breaker back on. If condition persists, call for service.
Cooling fan continues to run after oven is turned off	The electronic components have not yet cooled sufficiently.	The fan will turn off automatically when the electronic components have cooled sufficiently.
Oven light is not working properly	Light bulb loose or burned-out.	Reinsert or replace the light bulb. Touching the bulb with fingers may cause the bulb to burn out.
Oven light stays on	Door is not closing completely	Check for obstruction in oven door. Check to see if hinge is bent or door switch broken.
Cannot remove lens cover	Soil build-up around the lens cover.	Wipe lens cover area with a clean, dry towel prior to attempting to remove the lens cover.
Clock and timer are not working properly	No power to the range.	Check the circuit breaker or fuse box to your house. Make sure there is proper electrical power to the oven.

PROBLEM	POSSIBLE CAUSE	SOLUTION
Excessive Moisture		When using bake mode, preheat the oven first. Convection Bake and Convection Roast will eliminate any moisture in the oven.
Porcelain Chips	Porcelain interior is chipped by oven racks	When removing and replacing oven racks, always tilt racks upward and do not force them to avoid chipping the porcelain.

LIMITED WARRANTY

WARRANTY AND SERVICE

TO RECEIVE WARRANTY SERVICE, YOUR PRODUCT MUST BE REGISTERED.

TO REGISTER AND REVIEW FULL WARRANTY DETAILS, VISIT:

WWW.COSMOAPPLIANCES.COM/WARRANTY

SCAN TO REGISTER



CUSTOMER SUPPORT

TO CHAT WITH US LIVE FOR ASSISTANCE, VISIT:

WWW.COSMOAPPLIANCES.COM/CHAT

SCAN TO CHAT



IMPORTANT

Do Not Return This Product To The Store

If you have a problem with this product, please contact COSMO Customer Support at

+1 (888) 784-3108

DATED PROOF OF PURCHASE, MODEL #, AND SERIAL # REQUIRED FOR WARRANTY SERVICE.

IMPORTANT

Ne pas Réexpédier ce Produit au Magasin

Pour tout problème concernant ce produit, veuillez contacter le service des consommateurs Cosmo Customer Support au

+1 (888) 784-3108

UNE PREUVE D'ACHAT DATEE EST REQUISE POUR BENEFICIER DE LA GARANTIE.

IMPORTANTE

No regrese este producto a la tienda

Si tiene algún problema con este producto, por favor contacte el ayuda al cliente COSMO al

+1 (888) 784-3108

(Válido solo en E.U.A.)

NECESITA UNA PRUEBA DE DE COMPRA FECHADA, NÚMERO DE MODELO Y DE SERIE PARA EL SERVICIO DE LA GARANTÍA.



Correct disposal of this product:

This marking indicates that this appliance should not be disposed with other household wastes. To prevent possible harm to the environment or human health from uncontrolled waste disposal, recycle it responsibly to promote the sustainable reuse of material resources.

MEMO

A series of horizontal dashed lines for writing.



APPLIANCES

Cosmo is constantly making efforts to improve the quality and performance of our products, so we may make changes to our appliances without updating this manual.

Electronic version of this manual is available at:
www.cosmoappliances.com