



SPEC SHEET

KoolMore 30" x 60" 18-Gauge 304 Stainless Steel Commercial Work Table with Casters

Model: CT3060-18C

FEATURES

- **Versatile Workspace:** KoolMore Stainless-Steel Work Table supports woodworking, mechanical projects, DIY crafting, and food prep for homes, small businesses, cafes, or restaurants.
- **Food-Grade Stainless-Steel:** Made from durable, easy-to-clean stainless-steel, ideal for maintaining hygiene in kitchens, garages, or other workspaces.
- **Portable Design:** Equipped with rolling, lockable caster wheels for easy mobility and secure placement in any work environment.
- **Extra Storage:** Includes additional storage space to keep tools, utensils, or ingredients organized and accessible.
- **Resilient and Convenient:** Strong construction ensures long-lasting use, with a sleek design that enhances workspace tidiness and functionality.



CLOSE UP IMAGES



TECHNICAL SPECS

Dimensions

Length	30
Width	60
Height	35
Shelf Width	60
Shelf Depth	30

Specs & Certification

Weightlbs	55
Top Capacity	679 lbs.
Exterior Material	430 Stainless-Steel
Gauge Of Stainless Steel	18
Certifications	NSF Certified for Sanitation

Plan View

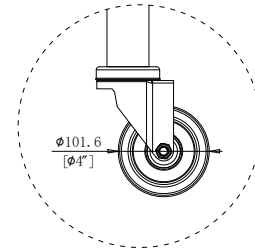
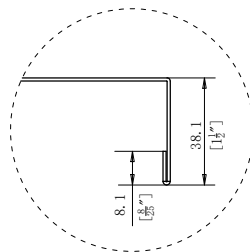
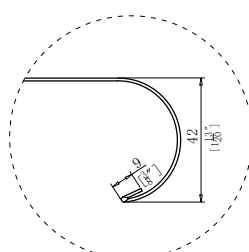
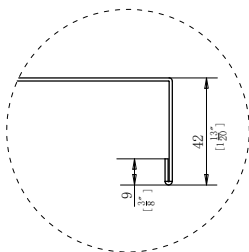
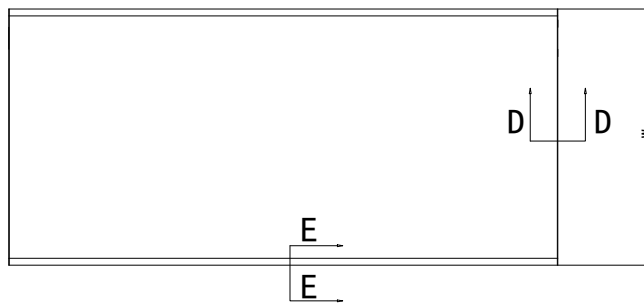
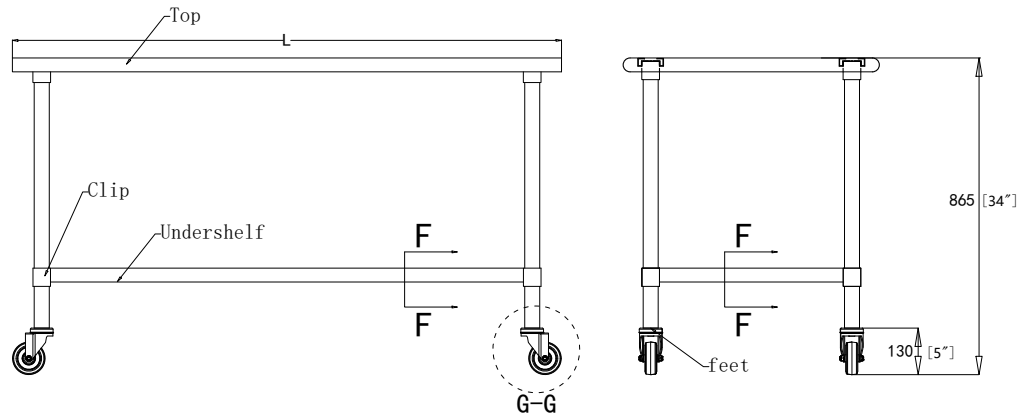

CERTIFICATIONS



706 Eastern Parkway STE 1G, Brooklyn NY 11213
 718-576-6342
 info@koolmore.com