



VIKING

User Guide

All Refrigerator

FDREIC7240L - FDREIC7240R - FDREIC7300L - FDREIC7300R
FDREIC7360L - FDREIC7360R

All Freezer

FDFZIC7180L - FDFZIC7180R - FDFZIC7240L - FDFZIC7240R
FDFZIC7300L - FDFZIC7300R - FDFZIC7360L - FDFZIC7360R

Bottom Mount

FDBMIC7360L - FDBMIC7360R

1. IMPORTANT SAFETY AND ENVIRONMENTAL INFORMATION	6
1.1. For your safety.....	6
1.2. In daily use.....	7
1.3. Caring for the environment.....	8
1.4. Cleaning, sanitization and maintenance of the ice and/or water dispenser (if present).....	8
1.5. Information for regulatory authorities.....	9
1.6. To save energy.....	9
2. INSTALLATION	10
2.1. Installation.....	10
2.2. Connection to the water system.....	10
2.3. Connection to the electrical power supply.....	11
2.4. Refrigerant.....	11
3. BEFORE STARTING	12
3.1. Getting started.....	12
3.2. Manufacturer's liability.....	12
3.3. Technical support.....	12
3.4. Product plate.....	12
3.5. Electronic Control.....	14
3.6. Main control panel.....	14
4. TURNING THE PRODUCT ON	15
4.1. Turning on and off.....	15
5. COMPARTMENT TEMPERATURE SETTING	18
5.1. How to adjust the temperature to meet different needs.....	18
5.2. Information and malfunction messages on the display.....	19
6. FUNCTIONS AND SETTINGS	20
6.1. Functions.....	20
6.2. Settings.....	27
7.1. Positioning, adjusting and internal drawers removal.....	33
7. LAYOUT	33
8.1. Activation and use of the Ice Maker.....	34
8. ACTIVATING AND USING THE ICE MAKER	34
8.2. Internal water filter.....	35
8.3. External water filter for freezer column Ice Maker.....	35
9. LIGHTING	36
9.1. Compartment lighting.....	36
10. CONSERVATION OF FOODS	36
10.1. General directions.....	36
10.2. How to maintain good food quality.....	37
10.3. Tips for food storage.....	38
11.1. Care and Cleaning.....	41
11. CARE AND CLEANING	41
11.2. Internal cleaning.....	41
11.3. Cleaning of the ventilation grill, filter and condenser.....	42
11.4. Condenser Cleaning.....	43
12. TROUBLESHOOTING GUIDE	44
12.1. Troubleshooting Guide.....	44
12.2. Malfunction messages appearing on the display.....	46



This is the safety alert symbol. This symbol alerts you to potential hazards that can kill or hurt you and others. All safety messages will follow the safety alert symbol and either the word "DANGER" or "WARNING."

These words mean:



You can be killed or seriously injured if you don't follow instructions.



You can be killed or seriously injured if you don't immediately follow instructions.

All safety messages will tell you what the potential hazard is, tell you how to reduce the chance of injury, and tell you what can happen if the instructions are not followed.

SAVE THESE INSTRUCTIONS!



IMPORTANT SAFETY INSTRUCTIONS

This manual contains operational instructions for the users of the appliance. Keep this manual in an easily accessible place for future reference. Improper installation, adjustment, alteration, service or maintenance can cause property damage, injury, or death.

Read the installation, operating, and maintenance instructions thoroughly before installing or servicing this equipment.

To reduce risk of fire, electric shock, or injury to persons when using your appliance, follow basic precautions, including the following:

- > Children should be supervised to ensure that they do not play with the appliance.
- > This appliance is not intended for use by persons (including children) with reduced physical, sensory or lack of experience and knowledge unless they have been given supervision or instruction concerning use of the appliance by a person responsible for their safety.
- > This appliance is designed to refrigerate beverages and foods and is intended for domestic use.
- > This appliance is intended to be used in household and similar applications such as: staff kitchen areas in shops, offices, and other working environments; farm houses and by clients in hotels, motels, and other residential-type environments; bed and breakfast-type environments; and catering and similar non-retail applications.
- > Do NOT use an extension cord or adapter.
- > Plug into a grounded 3 prong outlet.
- > Do not remove ground prong.
- > If available, ice make kit can be added to some models. See serial tag inside the food compartment of appliance for ice maker kit model information.
- > A qualified service technician must connect ice maker (if available) and the appliance to the water supply system (if the appliance has water load included).
- > If present, clean the ice bucket or drawer regularly but using only drinking water.
- > The appliance should be supplied only with drinkable water (if is --- a water connection).



In the event of a power failure, do not attempt to operate this appliance.



Keep the appliance area free and clear from combustibles or flammable materials and vapors.



Keep ventilation openings, in the appliance enclosure or in the built-in structure, clear of obstruction. Do not obstruct the air intake or exhaust openings of the appliance.



Do not store explosive substances such as aerosol cans with a flammable propellant in this appliance.



Do not use electrical appliances inside the food storage compartments of the appliance, unless they are of the type recommended by the manufacturer.

IMPORTANT SAFETY INSTRUCTIONS FOR PROPER DISPOSAL OF YOUR OLD REFRIGERATOR

▲WARNING

Suffocation Hazard

Remove doors or lid from your old appliance.

Failure to do so can result in death or brain damage.

▲WARNING Risk of child entrapment.

Before you throw away your old refrigerator or freezer:

- > Take off the doors.
- > Leave the shelves in place so that children may not easily climb inside.
- > **IMPORTANT:** Child entrapment and suffocation are not problems of the past. Junked or abandoned refrigerators are still dangerous, even if they will sit for "just a few days." If you are getting rid of your old refrigerator, please follow these instructions to help prevent accidents.

Important information to know about disposal of refrigerants:

Dispose of refrigerator in accordance with federal and local regulations. Refrigerants must be evacuated by a licensed, EPA-certified refrigerant technician in accordance with established procedures.

IMPORTANT SAFETY INSTRUCTIONS FOR MAINTENANCE AND CARE

▲DANGER

Risk of fire or explosion due to puncture of refrigerant tubing; follow handling instructions carefully. Flammable refrigerant used.

▲WARNING

To be repaired only by trained service personnel.

Use only manufacturer-authorized service parts. Do not use replacement parts that have not been recommended by the manufacturer (e.g, parts made at home using a 3D printer). If power supply cord is damaged, it must be replaced by the manufacturer, its service agent, or a similarly qualified person in order to avoid a hazard. Any repair equipment used must be designed for flammable refrigerants. Follow all manufacturer repair instructions. Use nonflammable cleaner.

▲WARNING

Do not puncture refrigerant tubing, do not damage the refrigerant circuit.

▲WARNING

Do not use mechanical devices or other means to accelerate the defrosting process, other than those recommended by the manufacturer.

TIP OVER HAZARD

▲WARNING

Refrigerator is top heavy and tips easily when not completely installed; to avoid a hazard due to instability of the appliance, it must be fixed in accordance with the instructions (see instruction manual provided). Keep doors taped closed until refrigerator is completely installed.

Use two or more people to move and install refrigerator.

Failure to do so can result in death or serious injury.

1. IMPORTANT SAFETY AND ENVIRONMENTAL INFORMATION

1.1. For your safety

- > If this appliance is replacing an existing appliance which must be removed or disposed of, make sure that it does not become a dangerous trap for children.
- > This appliance is designed to refrigerate beverages and foods and is intended for domestic use.
- > This appliance is for refrigeration and conservation of fresh and frozen foods in the home. Any other use is considered inappropriate.
- > This appliance is not designed to operate with external timers or with remote-control systems.
- > The appliance must be installed by following the instructions in the Installation Guide, particular care should be taken not to **obstruct the vent openings of the appliance and of the built-in units**.
- > The appliance features a concentrated lighting system with LED lamps. Do not stare at these lamps when they are on, as this could damage your vision. This warning is also included on the label attached to the inside of the refrigerator door.
- > When the freezer is operating, do not touch the interior stainless steel surfaces with wet or damp hands, as skin may stick to the very cold surfaces.
- > Do not use any type of electrical equipment inside the appliance.
- > Do not use any type of electrical equipment inside the food storage compartments.
- > When positioning the shelves, do not place fingers in the shelf slide guides.
- > Never attempt to extinguish a flame/fire with water: unplug the appliance from the outlet and cover the flame with a fireproof blanket.
- > Do not position containers of flammable liquids near the appliance.
- > Completely switch off the appliance and unplug the power supply cable during cleaning operations. If the plug is not easily reached, it is a good idea to turn off the circuit breaker that corresponds to the outlet which the unit is plugged into.
- > Packaging materials can be dangerous for children: do not allow children to play with plastic bags, plastic film or polystyrene.
- > Any repairs must be performed by a qualified service technician.
- > This appliance is not intended for use by persons (including children) with reduced physical, sensory or mental capabilities or lack of experience and knowledge unless they have been given supervision or instruction concerning the use of the appliance by a person responsible for their safety. Children should be supervised to ensure that they do

not play with the appliance.

- > Do not damage the appliance's refrigerant circuit tubing.
- > Do not store explosive substances, such as aerosol cans with a flammable propellant, inside this appliance.
- > The amount of refrigerant gas contained in your appliance is indicated on the identification plate located inside the appliance. If the power cord of this appliance is damaged, it must be replaced by the manufacturer, customer service or a similarly qualified person.
- > Improper installations and repairs may put the user at considerable risk.
- > Repairs must be carried out by the authorized customer service.
- > Only original spare parts from the manufacturer can be used. Only with the use of these components does the manufacturer guarantee that the safety requirements of the product are complied with.
- > Repairs may be performed by the manufacturer, authorized customer service or a similarly qualified person only.
- > Plug the appliance into a grounded 3-poles outlet.
- > Do not remove the ground pole.
- > Do not use an adapter.
- > Do not use an extension cord.
- > Disconnect power to all units before servicing.
- > If the POWER CORD is damaged, it must be replaced by the manufacturer, an authorized service centre or a similar qualified person in order to avoid any hazards.
- > Children must be supervised to make sure they do not play with the appliance.
- > Do not modify this appliance.
- > Do not insert pointed metal objects (kitchen utensils or tools) into the slots in the appliance.
- > Do not touch (especially with wet hands) frozen products or put them in your mouth directly.
- > Do not store flammable, explosive or volatile substances inside the appliance.
- > Do not store explosive substances, such as spray bottles with flammable propellants, in the appliance.
- > Bottles containing beverages with a high alcohol content must be tightly closed and stored vertically.
- > Organic compounds, acids and essential oils can

corrode the seals and plastic surfaces if left in contact with them for extended periods.

- > Do not pull on the cable to unplug the appliance.

1.2. In daily use

- > Cleaning and maintenance meant to be performed by the user must not be carried out by unsupervised children.

- > Never defrost or clean the appliance with a steam cleaner! The steam may penetrate electrical parts and cause a short-circuit. Risk of electric shock!

- > Do not use pointed or sharp-edged implements to remove frost or layers of ice. You could damage the refrigerant tubes.

Leaking refrigerant may cause eye injuries or ignite.

- > Do not misuse the plinth, pull-out drawers, doors, etc. as a point of support or as a support.

- > Take care that no objects get stuck in the doors.

- > Before cleaning the appliance, pull out the power cord plug or turn off the safety switch. Do not pull out the power cord plug by tugging on the power cord.

- > Store high-percentage alcohol tightly closed and standing up.

- > Keep plastic parts and the door seal free of oil and grease. Greases attack the plastic material and the door seal becomes brittle and porous.

- > Never cover or block the appliance's ventilation openings.

- > Do not damage the cooling circuit (if can be accessed).

- > Do not use electrical appliances inside the appliance.

- > In the event of damage to the cooling circuit, avoid the use of open flames and ventilate the area properly.

- > Do not use the appliance or parts of it in any way other than those specified in this manual.

- > Keeping the door open for long periods can cause the temperature in the appliance compartments to rise considerably.

- > Perform cleaning of surfaces that may come into contact with food and accessible drainage systems regularly.

- > Store raw meat and fish in suitable containers in the refrigerator, so that it does not come into contact with other food or drip onto it.

- > If the appliance is left empty for long periods of time, switch it off, defrost it, clean it, dry it and leave the door open to prevent the development of mold inside.

- > Never place sharp metal objects such as knives,

forks, spoons and lids on the appliance during use.

- > Do not use abrasive or corrosive cleaning agents (e.g. scouring powders, stain removers or metallic scouring pads and sponges) on glass parts.

- > Do not sit on the appliance.

- > Do not sit or lean on the door or on any open drawers.

- > Do not put pressure on the door or handle to move the appliance.

- > Do not use electrical appliances (e.g. hair dryers) or sprays for defrosting which may ruin the plastic parts.

- > Do not use the appliance to cool rooms for any reason.

- > Always unplug the appliance in the event of a malfunction or when performing cleaning or maintenance.

- > Do not keep liquids in tins or glass containers in the freezer.

- > Do not place heavy objects on top of the appliance.

1. IMPORTANT SAFETY AND ENVIRONMENTAL INFORMATION

Symbols used in the Guide:



Note
Tips for the correct use of the appliance



Important
Directions to avoid appliance damage



Warning
Directions to prevent injury

1.3. Caring for the environment



This appliance must be disposed of separately from other waste at the end of its service life. Refer to local laws and regulations.

This appliance does not contain substances in quantities sufficient to be considered hazardous to health and the environment.

Make sure you dispose properly of all packing materials and refer to local laws and regulations.



Electric voltage | Electrocutation hazard
Disconnect the mains power supply. Unplug the appliance.

- > The appliance must not be disposed of with other waste. Contact local waste disposal centres about how to dispose of recyclable waste.
- > Prior to disposal, cut the power supply cord and remove the door and/or drawers.
- > During disposal, avoid damage to the refrigeration circuit.
- > Neither the refrigeration circuit nor the insulation contain substances that are damaging to the ozone layer
- > Our appliances are packaged in non-polluting and recyclable materials.
- > Deliver the packing materials to the appropriate recycling centre.



Plastic packaging | Choking hazard
Do not leave the packaging or any part of it unattended.
Do not let children play with plastic bags.

1.4. Cleaning, sanitization and maintenance of the ice and/or water dispenser (if present)

Failure to follow the instructions regarding sanitising can compromise the hygienic safety of the water dispensed.

- > When using the appliance for the first time and every time the filter is changed, it is recommended to let the water flow in the circuit using the “Circuit manual cleaning” function (see chap. 8) Circuit manual cleaning (not on Refrigerator models) on page 25).
- > If the water dispenser has not been used for more than 4/5 days, it is advisable to clean the circuit and run off the first litre (0,26 gal) of water.
- > Reposition the removable water dispenser (if present), ensuring your hands are hygienically clean.
- > Clean the ice bucket or drawer regularly using only drinking water.
- > The filter must be changed when indicated on the control panel or when the ice/water dispenser has not been used for more than 30 days.
- > With each filter replacement, sanitize the ice and/or water dispensing system using a food grade disinfectant (with sodium hypochlorite), which does not alter the characteristics of the materials. Rinse with at least 2 litres (0,53 gal) of water before use.
- > Only original spare parts supplied by the manufacturer should be used when replacing components in the ice and water dispenser.
- > Any work on the appliance must be carried out by a qualified technician or the Viking Service.



Warning
To avoid contamination of food, please respect the following instructions:

- > **Opening the door for long periods can cause a significant increase in temperature inside the appliance compartments.**
- > **Perform regular cleaning of surfaces that may come in contact with food and of accessible drainage systems.**
- > **Store raw meat and fish in suitable containers in the refrigerator, so that it does not come into contact with other food or drip onto it.**
- > **Two-star frozen-food compartments are suitable for storing pre-frozen food, storing or making ice cream and making ice cubes.**

**Warning**

> **Two-star frozen-food compartments are suitable for storing pre-frozen food, storing or making ice cream and making ice cubes.**

> **One-, two- and three-star compartments are not suitable for the freezing of fresh food.**

> **If the refrigerator is left empty for a long period, switch it off, defrost, clean and dry it, and leave the door open to prevent mold developing within the appliance.**

1.5. Information for regulatory authorities

> Ventilation requirements, dimensions and minimum space from the rear wall are provided in the “Installation” chapter of this manual.

> Contact the manufacturer for additional information.

1.6. To save energy

> Correct use of the appliance, correct packaging of foodstuffs, a constant temperature and food hygiene all have effects on the quality of storage.

> Keep the number of times that the doors are opened and the length of time they remain open to a minimum to avoid excessive warming.

> Clean the condenser periodically to prevent the appliance from losing efficiency (see page 43).

> Defrost frozen food in the refrigerator compartment in order to make use of the cold stored in the frozen foods.

2. INSTALLATION

2.1. Installation

Make sure that installation is performed correctly, adhering to all of the instructions in the specific installation guide provided with the appliance.



Warning

If any model has water connections, make them before connecting the machine to the electrical system.

- > **The appliance must be connected to ground in compliance with local electrical code.**
- > **Position the appliance with the aid of a second person.**
- > **Never use the open door to lever the appliance into position.**
- > **Avoid exerting too much pressure on the door when open.**
- > **The appliance must not be installed near heat sources. If this is not possible, suitable insulation must be used.**
- > **The appliance must not be exposed to direct sunlight.**
- > **Do not use the appliance outdoors.**
- > **Installation and servicing should be carried out by qualified personnel in compliance with current standards.**
- > **Ensure that an a licensed electrician performs the electrical connection.**
- > **If the power supply cable is damaged, to avoid any danger, contact an authorized servicer immediately and they will replace it, so as to prevent any risk.**
- > **Always put on the necessary Personal Protective Equipment (PPE) before performing any work on the appliance (installation, maintenance, positioning or handling).**
- > **Before performing any operation involving the appliance, switch off the circuit breaker.**
- > **If installed near another refrigerator, refer to the installation guide.**
- > **Do not try to repair the appliance yourself contact an authorized servicer.**
- > **Do not install/use the appliance outdoors.**
- > **WARNING: Make sure that the power supply cable does not become caught or damaged when positioning the appliance.**
- > **To prevent instability of the appliance, install and secure it correctly as indicated in the instructions provided in this manual.**
- > **This device can be used up to a maximum height of 6000 feet/2000 meters above sea level.**

2.2. Connection to the water system

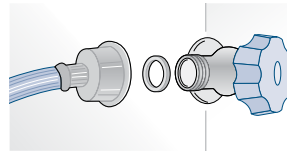

Models equipped with an Ice Maker require a connection to the domestic water supply system. It must be carried out using only the supplied new water inlet hose with $\frac{3}{4}$ " thread (do not use or reuse previously used tubing).

The system pressure must be between 0.05 MPa and 0.5 MPa (between 0.5 bar and 5 bar).

Any pressure outside of this range may cause the water system to malfunction or leak.



Important

Do not use extension cords and/or multiple adapters for connection.



Warning

Make sure that installation is performed correctly and in accordance with all of the instructions in the specific installation manual provided with the appliance.



Warning

Do not attempt to use a locally-sourced threaded garden hose adapter or braided supply line. It will strip the threads on the appliance's water connection solenoid.

2.3. Connection to the electrical power supply

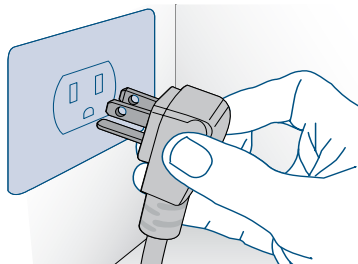

The appliance operates at 115 V AC, 60Hz and is equipped with a power supply cord with a 3-prong grounded plug, which must be connected to a corresponding 3-prong (15 Amp) grounding-type wall receptacle.



Important

Do not use extension cords and/or multiple adapters for connection.

2.4. Refrigerant

The refrigerant isobutane (R600a) is contained within the refrigerant circuit of the appliance, a natural gas with a high level of environmental compatibility, which is nevertheless flammable.

> **If the refrigerant circuit should become damaged, make sure that no flames and sparks develop in the room. Thoroughly ventilate the room in which the appliance is situated.**



ISO 7010 W021

Warning

Fire hazard / Flammable materials.

Use special care during transportation, installation and/or cleaning so as to avoid damaging the refrigeration circuit.

3. BEFORE STARTING

3.1. Getting started

Congratulations on purchasing your new Viking refrigerator! From now on you can use our innovative storage system, which will allow you to store all of your food in the best possible way. This manual will answer most of your questions about the product's features.



3.2. Manufacturer's liability

Viking declines all liability for damage to persons or property caused by:

- > uses of the appliance other than those specified;
- > failure to comply with the instructions in the user manual;
- > tampering with any part of the appliance;
- > use of non-original spare parts.

3.3. Technical support

- > In the event of appliance failure, contact technical support and have the repair carried out by qualified personnel only.
- > Make sure you have the model and serial number on hand (located on the identification plate).
- > Use only original spare parts.
- > Do not try to repair the appliance yourself or without the assistance of a qualified technician; this has safety repercussions and may void the warranty.
- > Detailed information on the duration of the warranty and the warranty conditions in each country

VIKING RANGE, LLC GREENWOOD, MISSISSIPPI 38930		LISTED HOUSEHOLD REFRIGERATOR Refrigerator-Fr						
MODEL/MODELE NUMBER/NUMERO	VKFDBMIC7360RA	VOLTS/FREQUENCY	115/60					
SERIAL/SERIE NUMBER/NUMERO	2525001050001	DEFROST SYSTEM WATTS	213					
REFRIGERANT TYPE	R600a	ICE MAKER ELEMENT WATTS						
BLOWING AGENT	HFO-1336mzz(Z)	CURRENT COOLING SYSTEM						
TOTAL GROSS VOLUME (L)	575	MAX. RATED CURRENT (A)	3,50					
FREEZING CAPACITY		REFRIGERANT TOTAL MASS (REFRIGERATOR/FREEZER)	(0,23 lbs (108 gms))					
REFRIGERANT CHARGE (oz) (gms)	<table border="1"> <tr> <td>FF</td> <td>FZ</td> </tr> <tr> <td>1,70 (48,00)</td> <td>2,10 (60,00)</td> </tr> </table>	FF	FZ	1,70 (48,00)	2,10 (60,00)	CLIMATE CLASS		
FF	FZ							
1,70 (48,00)	2,10 (60,00)							
WATER SUPPLY IN Mpa (bars), Min 0.15 (1.5) - Max 1								

Conservation Tips

- > SN (Subnormal) from +50°F to +90°F (+10° to +32°C).
- > N (Normal) from +61°F to +90°F (+16° to +32°C).
- > ST (Subtropical) from +64°F to +100°F (+18°C to +38°C).
- > T (Subtropical) from +64°F to +109°F (+18°C to +43°C).

can be found from Viking Customer Support, your dealer or on our website.

> If you need further information, do not hesitate to contact the Technical Assistance Centre:

Viking Range, LLC
111 Front Street
Greenwood, Mississippi 38930 USA
(662) 455-1200

For product information, call 1-888-(845-4641)
or visit the our web site at vikingrange.com



Important
Before calling, make a note of the appliance's serial number located inside the refrigerator compartment on the side opposite the door opening.

3.4. Product plate

The product plate shows the technical data, the serial number and the model. The product plate must never be removed or damaged.

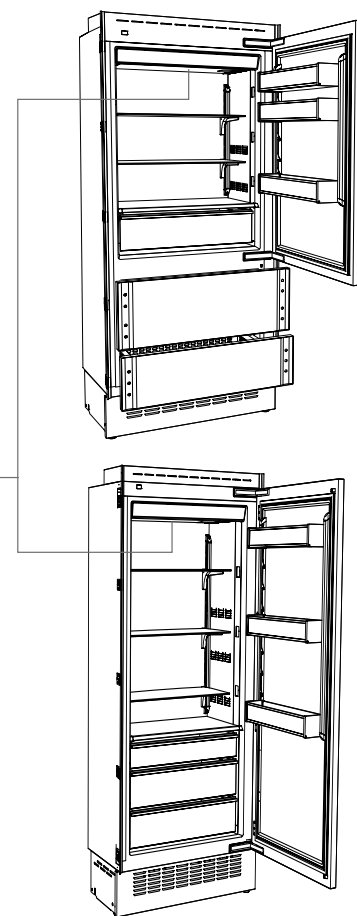

3. BEFORE STARTING

Refrigerator
+46/+35°F
(+7°C/+1°C)

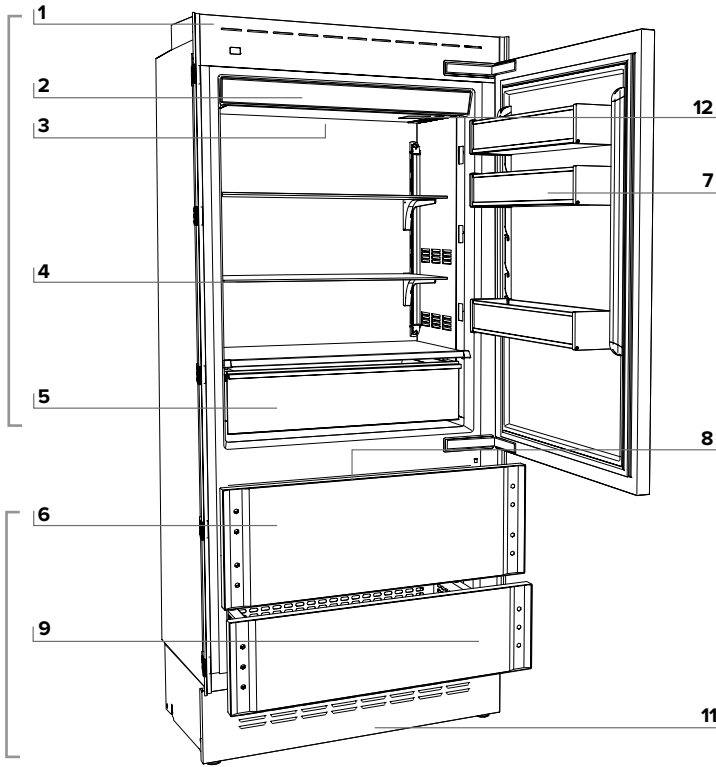

- 1) Stainless steel body.
- 2) Interactive control panel.
- 3) Water filter.
- 4) Patented shelf positioning system.
- 5) Refrigerator compartment drawers.
- 6) Ice maker container.
- 7) Door bins.
- 8) LED lights for the freezer compartment drawers.
- 9) Freezer compartment drawer convertible into Refrigerator or Fresco compartment (Fresh Select function).
- 10) AISI 304 stainless steel drawers.
- 11) Removable grill (condenser)
- 12) Product plate

Fresh Select
5°F/-8°F
(-13°C/-23°C)

Bottom Models

Refrigerator
+46/+35°F
(+7°C/+1°C)

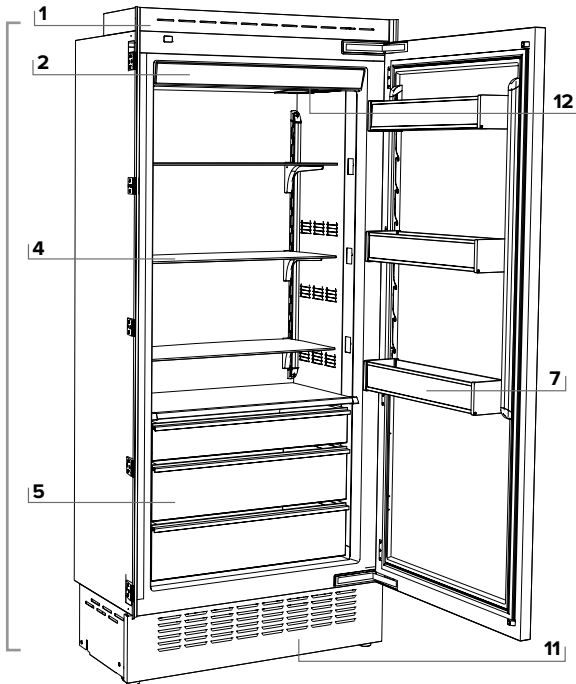

Refrigerator Models

Freezer
5°F/-8°F
(-13°C/-23°C)

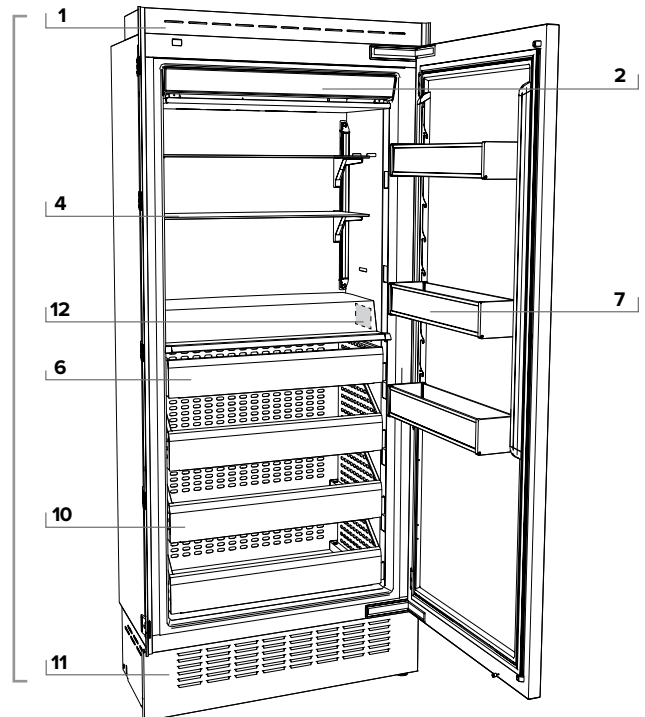

Freezer Models

3. BEFORE STARTING

3.5. Electronic Control

The innovative electronic control system designed by Viking maintains constant temperature in the compartments and visualizes it on the control panel display. It also allows user interaction making it possible to personalize settings of the various functions and to receive sound and/or visual messages should any malfunction occur in the appliance.

3.6. Main control panel

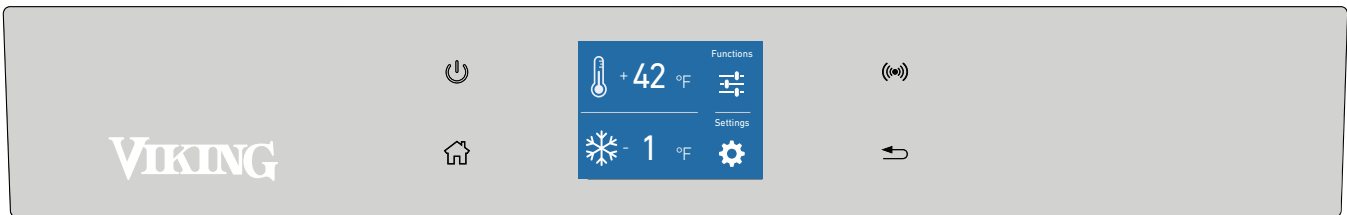

Turning On/Off
Touch the icon to turn the unit on or off.



Home
Touch the Home icon to go back to the home screen.



Alarm
Touch the icon to view the alarm tone functions and to deactivate them.



Back
Touch the arrow icon to go back to the previous screen.

4. TURNING THE PRODUCT ON

4.1. Turning on and off

First startup

Touch the **ON/OFF** . The display shows the following launch screens:



1) Viking logo

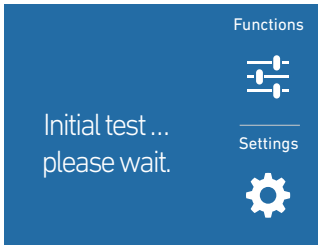

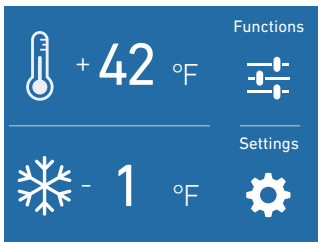

2) Initial test (lasts 3 minutes).

3) The display shows the main screen with the ambient temperature measured from the cellar inside the compartments. Automatically the unit start to cool down until reaching the set temperatures.



4) Home screen (*).

 Refrigerator compartment [+41°F (+5°C)]

 Fresh select compartment [0°F (-18°C)]

(* The home screen varies depending on the models;

The Fresh Select compartment is set in the freezer mode [0°F (-18°C)]. To change this setting see chap. 5) Fresh Select (only for Combi and Freezer models) on page 29.

When the appliance is first turned on, it is recommended to wait at least 12 hours before placing any food inside the unit. During this time, deactivate any error messages by touching the **ALARM**  button.

Turning off the appliance

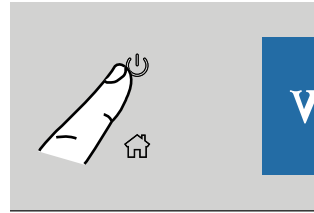

1) Touch the **ON/OFF**  button to switch off.

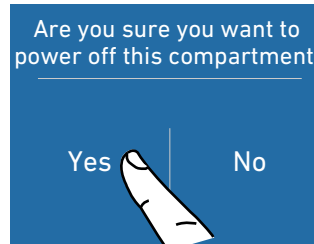

2) Confirm the shutdown touching the **YES** icon.

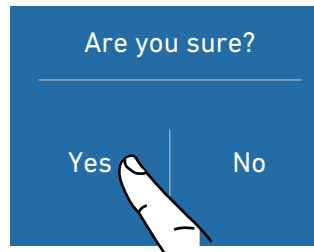

3) Confirm shutdown again touching the **YES** icon.



Note

When the unit is off there are no warning lights to show that the appliance is plugged into a socket.

4. TURNING THE PRODUCT ON

Refrigerator compartment shutdown

The refrigerator compartment, can be turned off individually whereas the Fresh Select drawer can be turned off only if the whole unit is turned off.

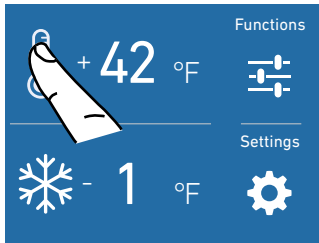

1) HOME screen. To turn off the refrigerator compartment or the Fresco compartment, touch the corresponding icon.

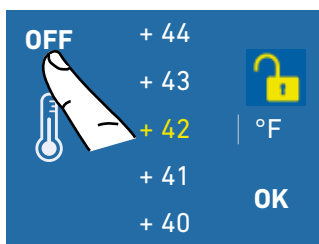

2) Touch the OFF icon.

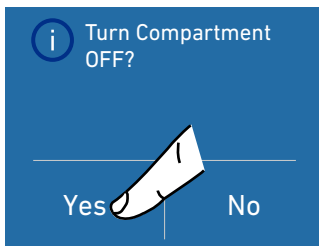

3) Confirm the shutdown touching the **YES** icon.



4) Confirm shutdown again touching the **YES** icon.

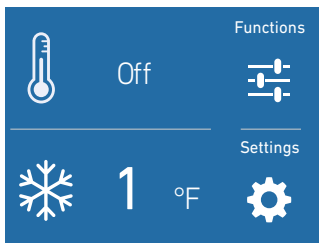

5) On the home screen, the **OFF** icon  appears, indicating that the Refrigerator compartment is off.

tor compartments. The refrigerator will start cooling until it reaches the set temperatures.

Turning the compartments back on

If the refrigerator compartment must be switched back on, follow this procedure:

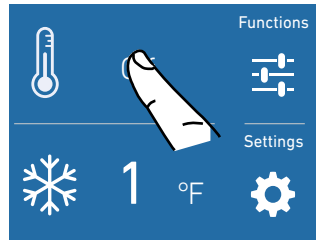

1) Home screen. To turn back on an off compartment, touch the **OFF** compartment next to it.

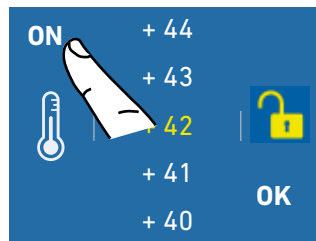

2) Touch the ON icon.

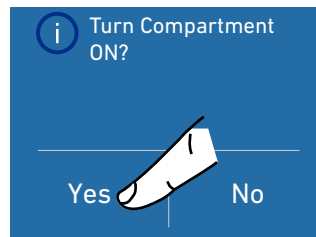

3) Confirm the turning on touching the **YES** icon.



4) Confirm the turning on again touching the **YES** icon.

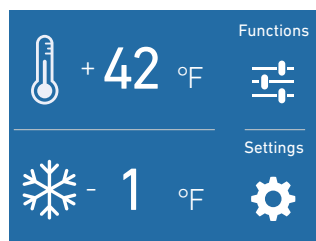

5) The refrigerator compartment switches back on and the **HOME** screen is displayed.

Turning the appliance back on

To turn the unit back on, press the **ON/OFF**  button. The display will turn on and the start screen and the home screen will be shown, once again displaying the temperature measured inside the refrigera-

4. TURNING THE PRODUCT ON

Turning off for long periods

During long periods of absence it is recommended that the appliance is turned off by pressing the **ON/OFF**  button and disconnecting the electrical plug or the breaker controlling the socket.

Empty the refrigerator completely, clean and dry it and leave the doors and drawers partially open to prevent unpleasant odours.



Note

If at the first startup the Viking message does not appear, but another message appears, it means that the appliance has already started the cooling process.

During the first startup, it will not be possible to use the Menu to modify the factory settings until the preset temperature has been reached. It is however possible to set the time and date immediately; these parameters are required to activate some of the special functions.

5. COMPARTMENT TEMPERATURE SETTING

5.1. How to adjust the temperature to meet different needs

Each model has been carefully tested before leaving the factory and is adjusted in such a way to ensure high performance and low consumption. Usually, it is not necessary to modify the settings.

Home screen in the various models:

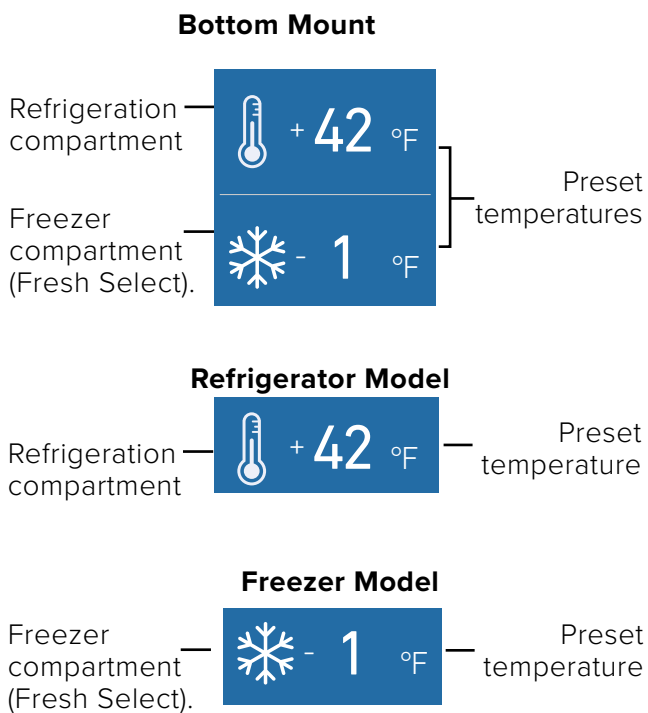

Modifying the compartment temperatures

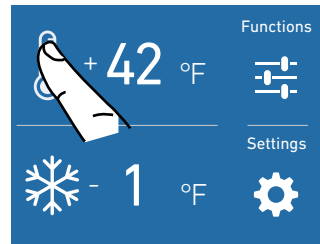

1) Home screen. Touch the refrigerator compartment icon  for example.

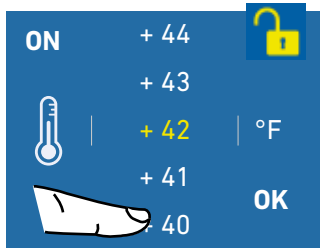

2) Scroll the values up or down to select the desired temperature (in the case of the Refrigerator compartment the temperature can be set from 36°F (+2°C) to 46°F (+8°C)

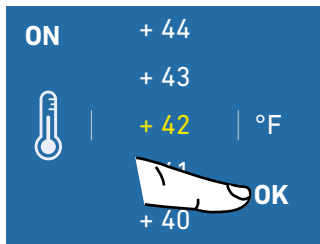

3) Touch the **OK** icon to confirm the selected temperature.



Note

The displayed temperature may vary slightly with respect to the set temperature if the doors are continuously opened or if large quantities at ambient temperature are inserted.

It takes 6 to 12 hours to reach the selected temperature.

5. COMPARTMENT TEMPERATURE SETTING

Padlock icon

The padlock icon appears when the temperatures are set up.

The padlock:



open means that you can modify the compartment temperatures.



closed means that you cannot modify the compartment temperatures.

Usually an open yellow padlock is displayed; in this case you can scroll up or down on the display, select the desired temperature and press **OK** to confirm.

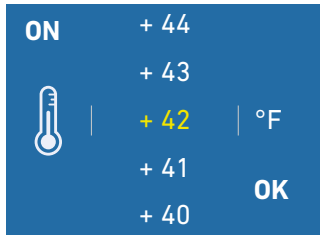

The padlock will instead be closed if the user has activated some functions (described in par. “6. FUNCTIONS AND SETTINGS” on page 20); in this situation, the user will no longer be able to change the temperatures of the compartments until the function is completed or if it is disabled manually.

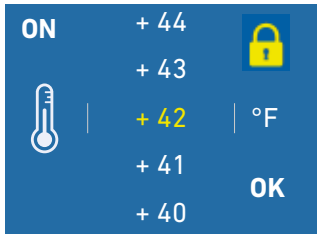

5.2. Information and malfunction messages on the display

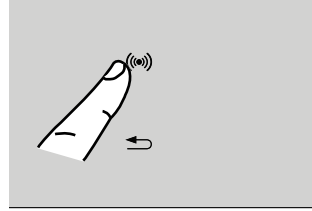

A built-in control system provides information using warning lights or text notifications, shown on the display.

The voiced notification that accompanies some of the warning notifications can be turned off by touching the **ALARM** (🔊) button on the main control panel.

The list of the anomalies can be found at the end of this manual (see paragraph Troubleshooting Guide page 44).

6. FUNCTIONS AND SETTINGS

6.1. Functions

Tailor the operation of the unit to suit the different ways in which you might want to use it.



1) Max Refrigerator
(Max Freezer in Freezer models)

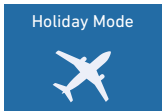

2) Vacation Mode



3) MaxCool Mode FreshSelect
(Freezer models only).



4) Bottle chiller | cooling bottles
(Freezer models only).



5) Ice Maker.
(Freezer models only).



6) Water Filter



7) Water Dispenser
(All refrigerator models).



8) Water System Purge
(Freezer models only).

1) Max Refrigerator (Max Freezer in Freezer models)

This feature lowers the refrigerator temperature to 36°F (+2°C) for 12 hours, allowing a more rapid cooling of the food that has just been placed inside. At the end of the 12 hours, the function deactivates automatically, and the previously set temperature is restored.

It is possible to program timed activation of this function. After a prolonged interruption of the electrical power, it is necessary to reactivate the function.

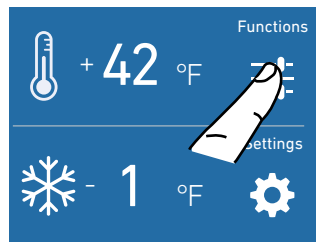

A) Home screen.
Touch the **FUNCTIONS** icon.



B) Touch the **MAXCOOL MODE** icon.

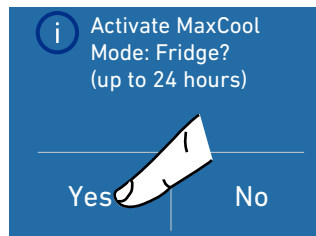

C) Touch the **YES** button to activate the function.

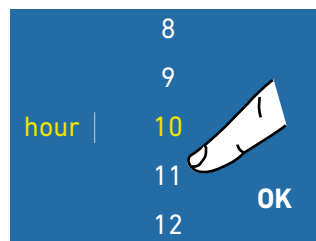

D) Scroll up/down to set the desired time (in hours) and then press **OK**.

6. FUNCTIONS AND SETTINGS

2) Vacation

This function (recommended in case of prolonged absences since it allows considerable energy savings) brings the refrigerator compartment temperature to 57.2°F (+14°C).

It is possible to program the duration, or it can be manually deactivated upon re-entry after a period of absence. This function remains active even if, during the period of absence, there is an extended interruption of electrical power.

It is possible to program a period from 1 to 90 days.

3) Max Freezer (available in freezer models)

This function must be activated at least 24 hours before inserting room temperature items into the freezer or several hours before putting into the freezer previously frozen items that have been subjected to a slight temperature rise.

This function is automatically deactivated when the programmed time period is up. It is possible to programme timed activation of this function. After a prolonged interruption of the electrical power, it is necessary to reactivate the function. It is possible to program the function with a delay of 1 to 12 hours.

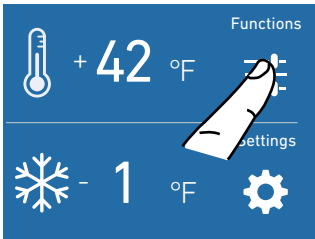

A) Home screen. Touch the **FUNCTIONS** icon.

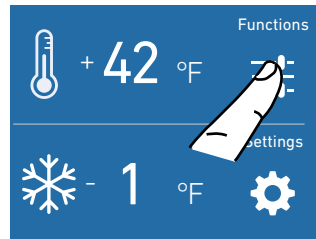

A) Home screen. Touch the **FUNCTIONS** icon.

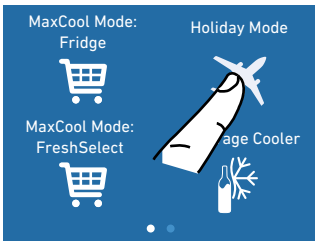

B) Touch the **VACATION** icon.



B) Touch the **MAXCOOL MODE FRESHSELECT** icon.

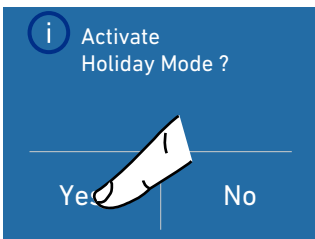

C) Touch the **YES** icon to activate the function.

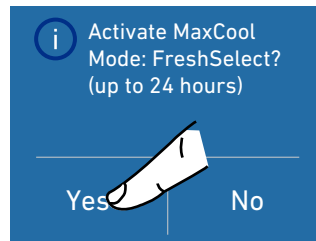

C) Touch the **YES** button to activate the function.

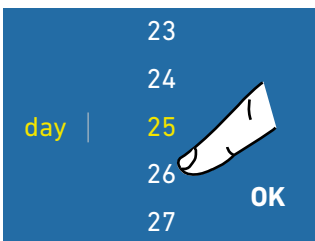

D) Scroll to set the desired time (in days) and then press **OK**.

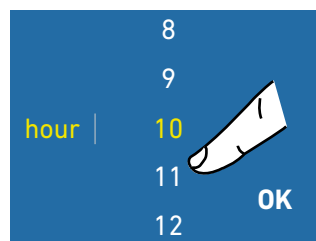

D) Scroll up/down to set the desired time (in hours) and then press **OK**.

6. FUNCTIONS AND SETTINGS

4) Bottle Chiller (bottle cooling) (Freezer models only)

This function can be activated when it is necessary to cool off beverages quickly by placing them inside the freezer compartment.

It is possible to select a duration of 1 to 45 minutes. A signal will sound to notify you when the optimal temperature has been reached.

After removing the beverages, deactivate the sound signal by pressing the **ALARM** (🔊) button.

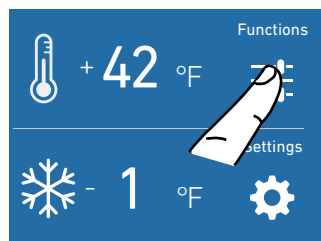

A) Home screen. Touch the **FUNCTIONS** icon.



B) Touch the **BEVERAGE COOLER** icon.



C) Touch the **YES** button to activate the function.

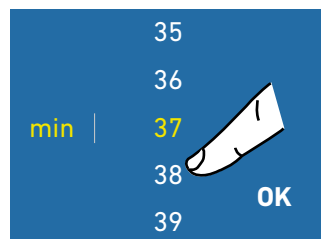

D) Scroll to set the desired time (in Minutes) and then press **OK**.

5) Ice maker activation/deactivation (only in Combi and Freezer models)

Before activating the Ice Maker for the first time, make sure that the water filter cartridge has been installed, and perform an initial washing of the hydraulic circuit (see chap. 8) Circuit manual cleaning (not on Refrigerator models) on page 25. After a few minutes the Ice Maker can be activated.



Important

Do not activate the Ice Maker unless the appliance is connected to the water mains.

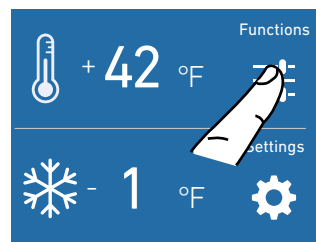

A) Home screen. Touch the **FUNCTIONS** icon.

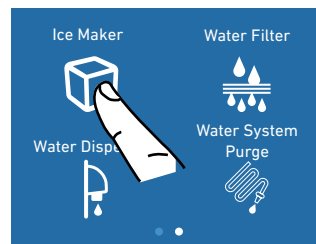

B) Scroll right twice and then touch the **ICE MAKER** icon.

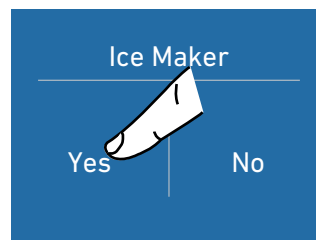

C) Touch the **ON** button to activate the function, touch the **OFF** button to deactivate the function (for instance if it is necessary to disconnect the appliance from the water mains).

Setting the ice cubes size and Max Ice function

The **ICE MAKER** function allows selecting the size of the ice cubes, choosing between large (base setting) or medium, and activate the **MAX ICE** function, which increases the quantity of produced ice. The **MAX ICE** function deactivates automatically after 24 hours.

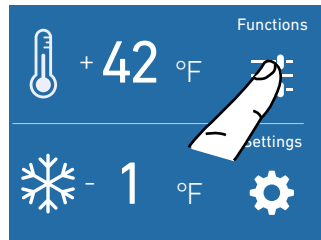

A) Home screen. Touch the **FUNCTIONS** icon.

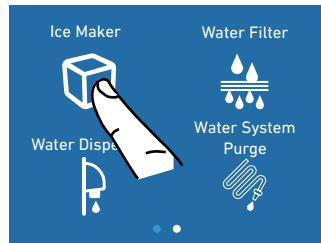

B) Scroll right twice and then touch the **ICE MAKER** icon.

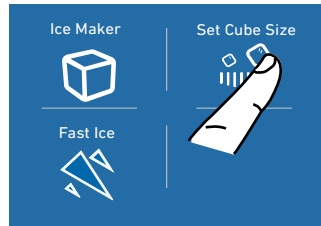

C) Touch the ice **SIZE** icon.

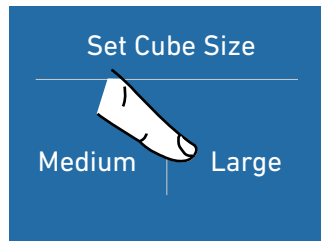

D) Select the desired ice cube size (MEDIUM or LARGE).

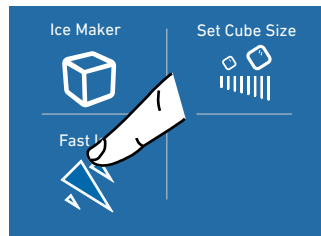

E) To increase the quantity of ice produced (up to 1.5 kg of ice a day), touch the **MAX ICE** icon.

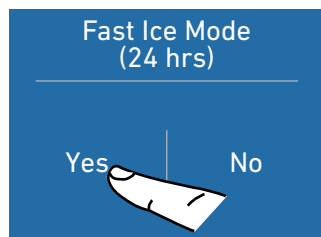

F) Confirm the function touching the **YES** button.

6) Water filter - activation

The water filter is essential for the purification of the water used for making ice, for cleaning the circuit or for supplying water for the Refrigerator compartment (water dispenser available on the Refrigerator models).

The display allows viewing the time left before the filter needs to be replaced.

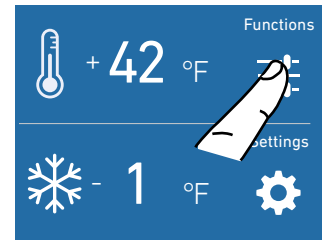

A) Home screen. Touch the **FUNCTIONS** icon.

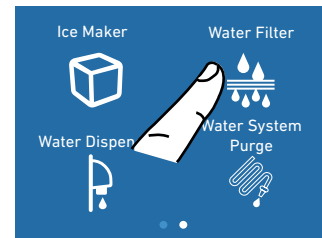

B) Scroll right twice and then touch the **WATER FILTER** icon.

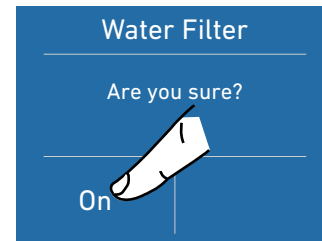

C) Confirm the function touching the **YES** icon.

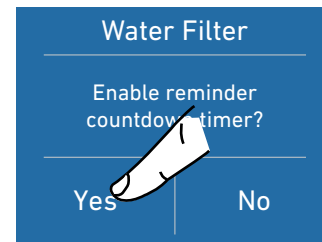

D) Confirm the function again touching the **YES** icon. This way you will be warned when the filter needs to be changed.

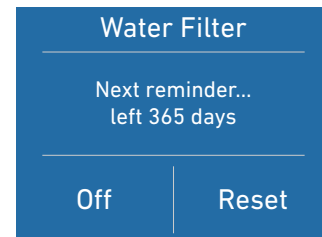

E) Here are indicated the days left before the due date for the filter replacement. Touch the **HOME** icon  screen.

6. FUNCTIONS AND SETTINGS

6a) Water filter - deactivation

To deactivate a filter-reminder countdown, follow these steps:

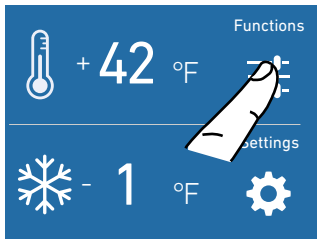

A) Home screen.
Touch the **FUNCTIONS** icon.

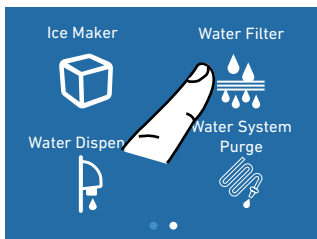

B) Scroll right twice and then touch the **WATER FILTER** icon.

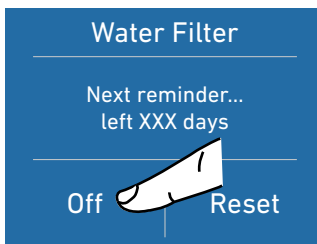

C) Press **OFF** to deactivate the water filter reminder.

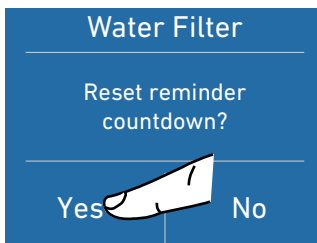

D) Touch YES to proceed.

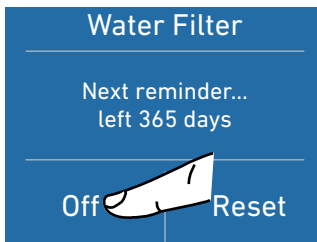

E) Confirm the function again touching the **OFF** icon.
Touch the **HOME**  screen.

6a) Reset Filter

The Reset Filter function resets to zero the time left before the filter needs to be replaced. The meter must be reset to zero each time the cartridge is replaced.

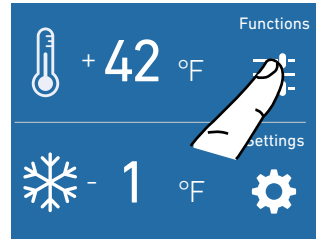

A) Home screen.
Touch the **FUNCTIONS** icon.

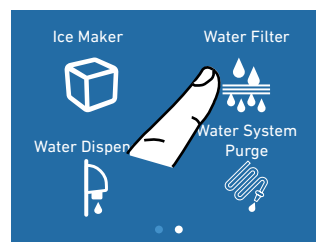

B) Scroll right twice and then touch the **WATER FILTER** icon.

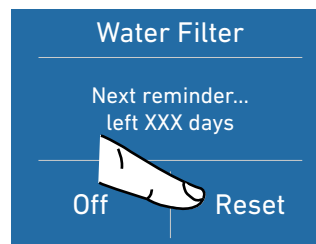

C) Press **RESET**.

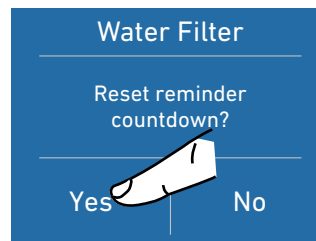

D) Touch the **YES** button to proceed.

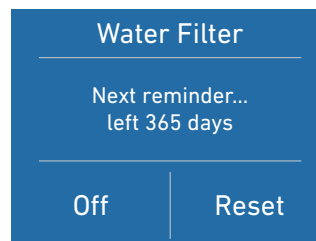

E) Here are indicated the days left before the due date for the filter replacement. Touch the **HOME**  screen.

6. FUNCTIONS AND SETTINGS

7) Water dispenser (only for Refrigerator models)

The function water dispenser is available in refrigerator models and enables the supply of cold filtered water.

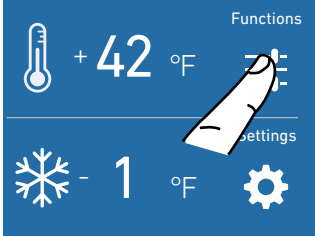

A) Home screen. Touch the **FUNCTIONS** icon.

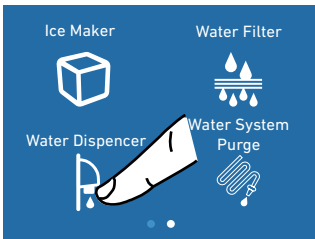

B) Scroll right twice and then touch the **WATER DISPENSER** icon.

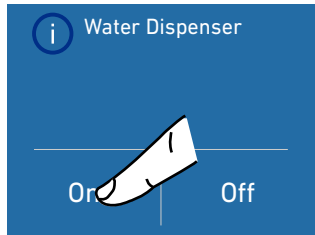

C) Touch the **ON** icon to confirm activation.

8) Circuit manual cleaning (not on Refrigerator models)

If ice production has been switched off or remained unused for a long period, it is recommended that you run the Manual Cleaning function. Before proceeding, it is important to turn off the Ice Maker.

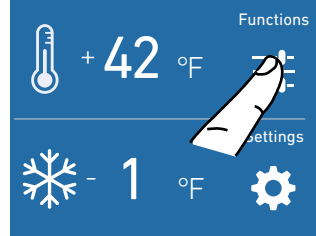

A) Home screen. Touch the **FUNCTIONS** icon.

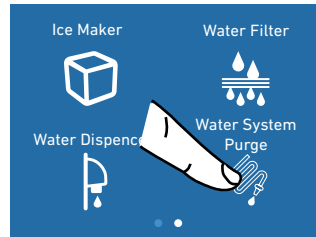

B) Scroll right twice and then touch the **WATER SYSTEM PURGE** icon.

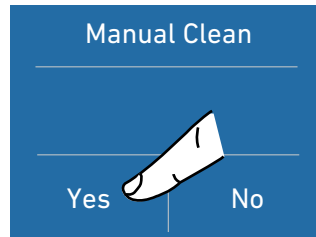

C) Touch the **YES** icon to confirm the cleaning.

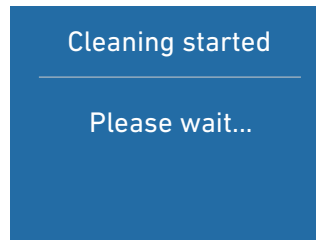

D) Wait...

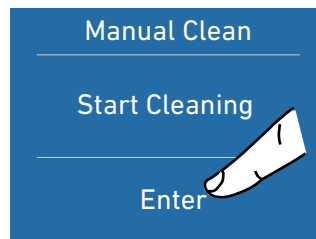

E) Touch the **ENTER** icon to start the washing.

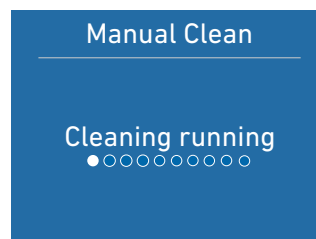

F) Washing in progress

6. FUNCTIONS AND SETTINGS

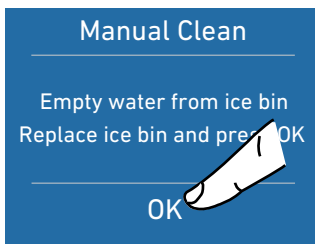

G) When the washing is complete, press **OK** and empty the bowl.

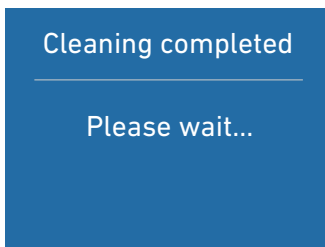

H) Wait for a few seconds to return to the main menu screen

Repeat the cleaning until the water in the ice compartment tray is clean.



Position the ice tray or a suitable bowl for collecting any water correctly beneath the Ice Maker and then close the drawer. When the process is complete, clean the ice tray.

Bypass filter

The built-in filtration system can be bypassed when the home water system provides water of excellent quality.

Simply remove the water filter from the adapter and the system will automatically bypass the cartridge.

6. FUNCTIONS AND SETTINGS

6.2. Settings

It is possible to customize the settings of your appliance to adapt it to your different requirements.



1) Date.



2) Time.



3) Degrees Celsius and Fahrenheit.



4) Language



5) Fresh Select (only for Combi and Freezer models)

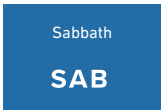

5) Sabbath.



6) Reset.

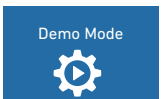

7) Demo Mode.

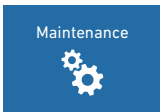

8) Maintenance.

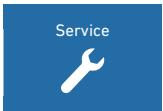

9) Service.

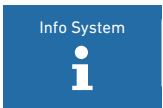

10) InfoSystem.



11) Plasmacluster (only for Combi and Refrigerator models)

1) Date

The display will show the date in the format (day:month:year).

You can modify the settings by touching the display.

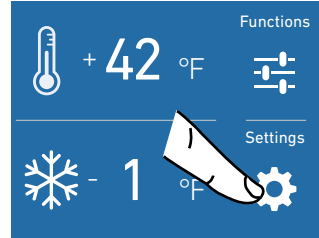

A) Home screen. Touch the **SETTINGS** icon.

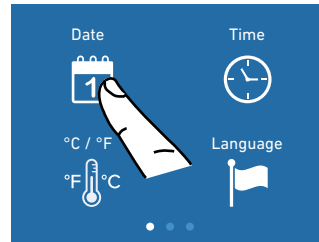

B) Touch the **DATE** icon.

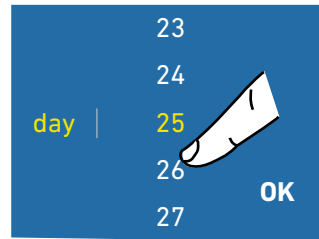

C) Scroll up and down to select the desired day and touch **OK**.

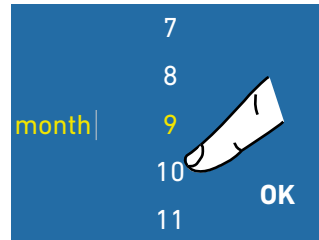

D) Scroll up or down to select the desired month, then touch **OK**.

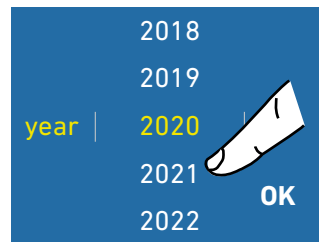

E) Scroll up or down to select the desired year, then touch **OK**.

6. FUNCTIONS AND SETTINGS

2) Time

The display shows the hours and minutes in the format hh:mm. This function allows you to select a 12 or 24 hr. clock mode.

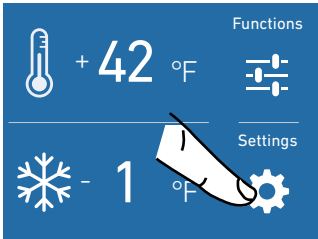

A) Home screen. Touch the **SETTINGS** icon.

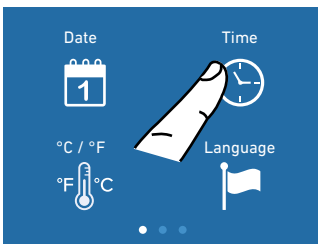

B) Touch the **TIME** icon.

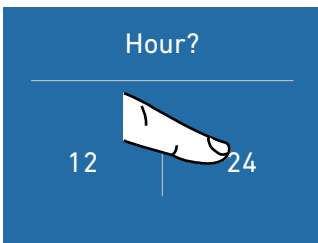

C) Select the mode in which you want to see the time: 12 or 24 hr.

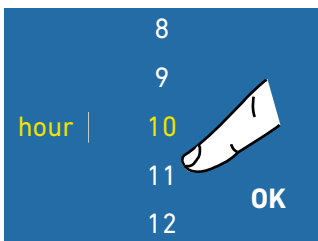

D) Scroll up or down to select the time and then touch **OK**.

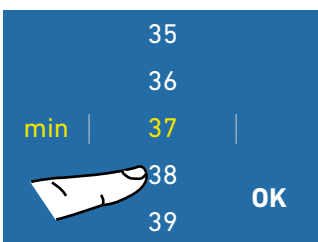

E) Scroll and select the minutes and then touch **OK**.

3) °F/°C

This function allows visualizing the temperature in degrees Fahrenheit (default) or Centigrade.

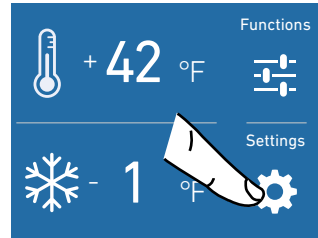

A) Home screen. Touch the **SETTINGS** icon.

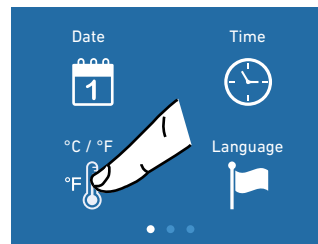

B) Touch the **°F/°C** icon.

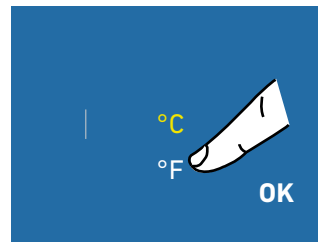

C) Scroll up or down to select the degrees in Centigrades or Fahrenheit and press **OK**.

4) Language

To set the language of the appliance, simply follow the procedure.

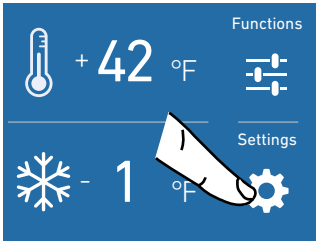

A) Home screen. Touch the **SETTINGS** icon.

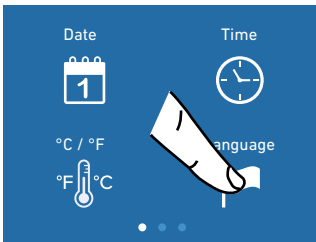

B) Touch the **LANGUAGE** icon.



C) Scroll up or down to select the desired language and press **OK**.

5) Fresh Select (only for Combi and Freezer models)

The freezer compartment can, if required, be converted to the refrigeration or Fresco operating mode.

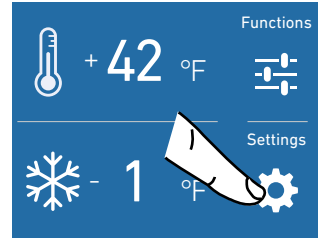

A) Home screen. Touch the **SETTINGS** icon.

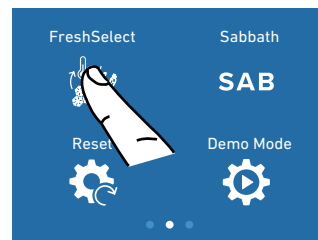

B) Scroll twice right and touch the **TRIMODE** button.



C) Scroll up/down, select one of the three functions and press **OK**.

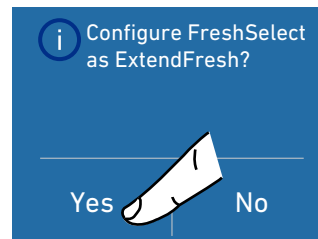

D) Touch **YES** to confirm the function.

6. FUNCTIONS AND SETTINGS

5) Sabbath Mode

The function makes it possible to comply to certain religious observances requiring that the operation of the appliance is not affected by the opening or closing of the doors (the thermostatic control, the inner lighting and the ice maker are deactivated).

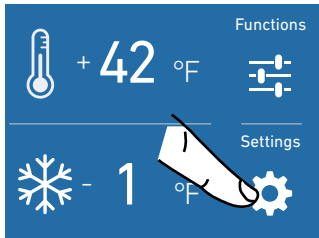

A) Home screen. Touch the **SETTINGS** icon.

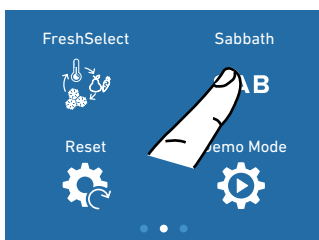

B) Scroll right twice and touch the **SABBATH** icon.



C) Touch the ON button to activate the function.

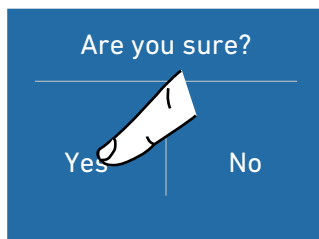

D) Touch the **YES** button to activate the function.



E) The appliance will work according to this configuration.

6) Reset

It gives the possibility to restore the base settings that were set in the factory, cancelling all the changes that has been made from there onward.

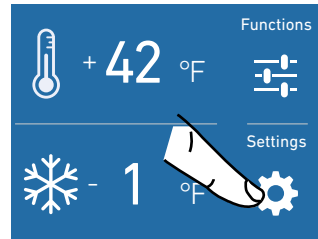

A) Home screen. Touch the **SETTINGS** icon.

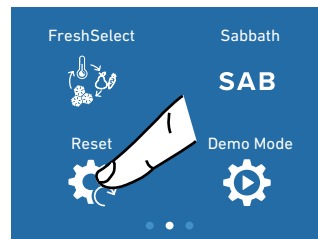

B) Scroll right twice and select the **RESET** icon.

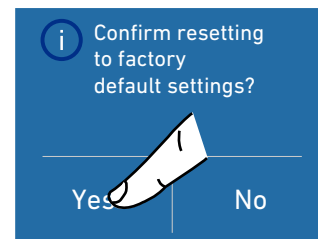

C) Touch the **YES** button to reset.

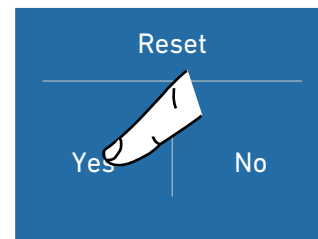

D) Touch the **YES** button.

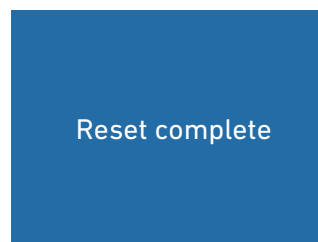

E) The reset has been performed. The appliance factory settings have been restored.



Important

If you restore the base settings ("reset"), it is necessary to set again the choice of the functioning of the trimode drawer that has been made, in case they were set before as Refrigerator or fresco.

6. FUNCTIONS AND SETTINGS

7) Demo Mode

It is possible to simulate the functioning of the product, for showroom display.

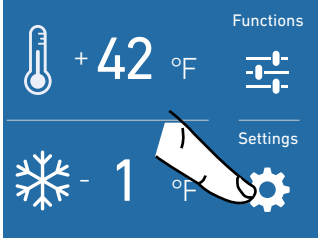

A) Home screen. Touch the **SETTINGS** icon.

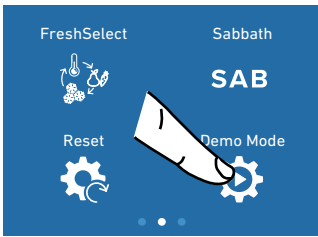

B) Scroll right twice and select the **DEMO MODE** icon.

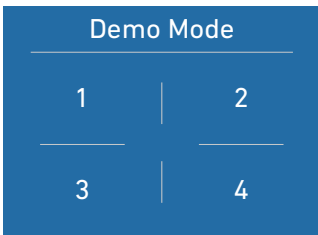

C) Enter the **PASSWORD** necessary to activate, that must be requested from the Manufacturer. Default password: 1-2-3-4

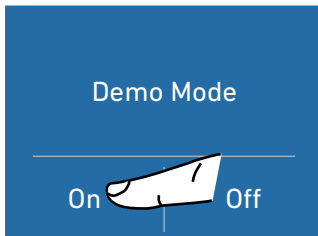

D) Touch the **ON** or the **OFF** button.

9) Maintenance

In order for the unit to operate correctly, the ventilation grill, filter and condenser must be cleaned periodically. See the instructions on page 41.

The recurring cleaning every 12 months is reminded by an acoustic and optical signal on the display.

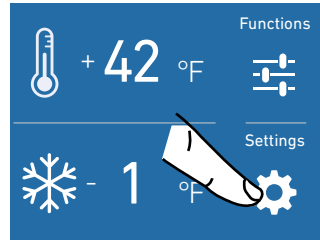

A) Home screen. Touch the **SETTINGS** icon.

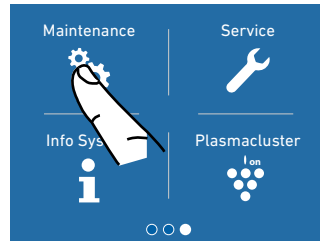

B) Scroll right twice and select the **MAINTENANCE** icon.

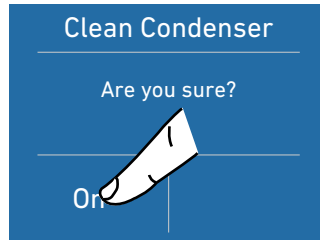

C) To enable it, touch the **ON** icon.

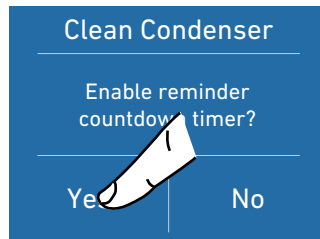

D) To enable the reminder, touch the **YES** icon.

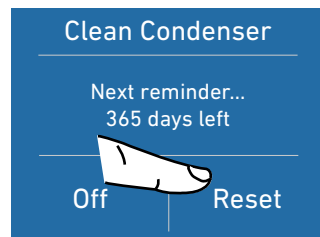

E) However, if you want to reset the previously set warning, touch the **RESET** icon.

6. FUNCTIONS AND SETTINGS

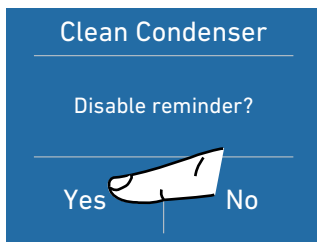

F) The alert can be disabled and the time left before the next cleaning viewed touching the **YES** button.

9) Service

The Service  function is reserved for Viking Customer Service.

10) Info System

The Info System function displays the product data, such as the software code, the serial number and the appliance factory codes.

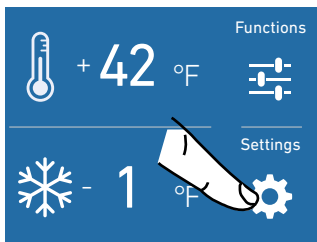

A) Home screen. Touch the **SETTINGS** icon.

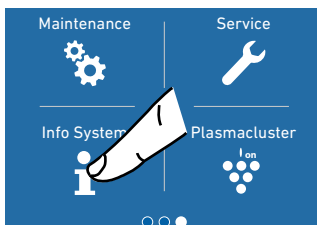

B) Touch the **INFO SYSTEM** icon.

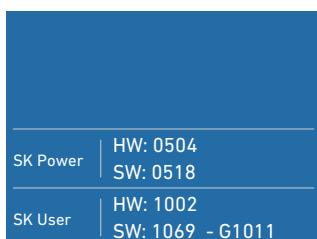

C) Information about the appliance is displayed.

11) Plasmacluster (only for Combi and Refrigerator models)

The ionizer inside the refrigerator releases clusters of ions—groups of positive and negative ions—into both the freezer and refrigerator compartments. These ion clusters help reduce the formation of mold and bacteria. You may notice some mild odors in the refrigerator; this is the smell of ozone, which is generated by the ionizer. The amount of ozone is minimal and it quickly decomposes within the compartment. The Plasmacluster remains active only when the refrigerator door is closed.

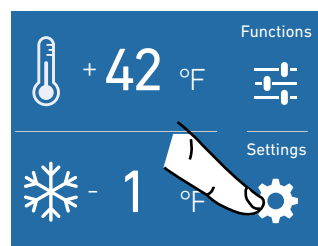

A) Home screen. Touch the **SETTINGS** icon.

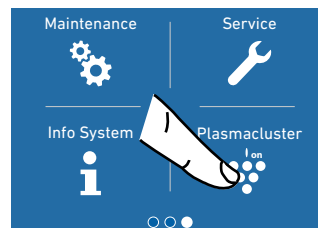

B) Touch the **PLASMACLUSTER** icon.

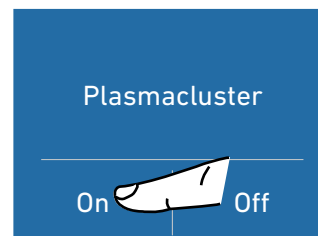

C) Touch the **ON** or the **OFF** button.

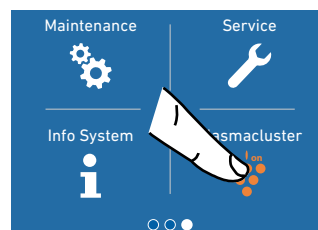

D) The icon light turns orange when the function is active.

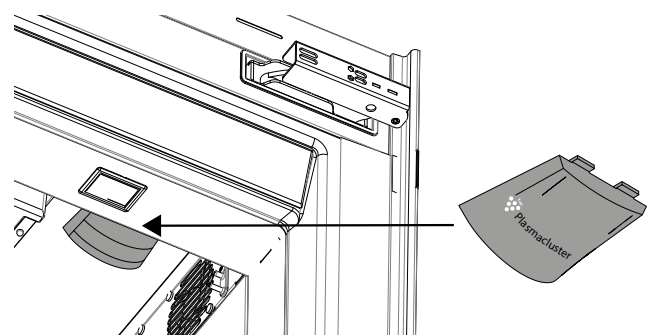

7. LAYOUT

7.1. Positioning, adjusting and internal drawers removal.

Fresco drawer

It is positioned on the slides; to remove the drawer, take it out completely and unscrew the two side thumbscrews, lift it and take it out.

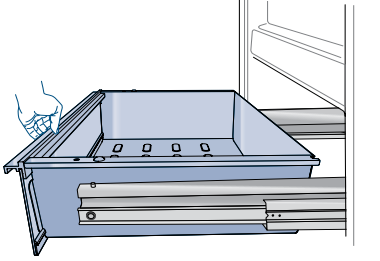

Fresh Select drawer

The upper Fresh Select can be removed using the same method used for the Fresco drawer. To remove the inner Fresh Select drawer unscrew the thumbscrews.

When replacing the drawers, make certain the back of the drawers engage under the clips on the slide guides.

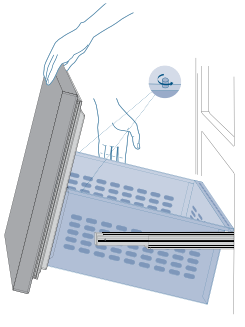

Ice Bin

The ice bin is located in the upper drawer of the freezer compartment (on some models it is fixed with locking panels). After removal, make sure to reposition it correctly.

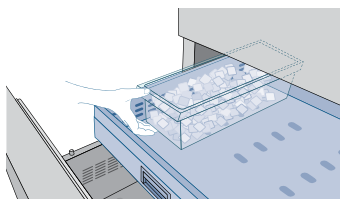

Internal glass shelves

The shelves are sliding and can be easily re-positioned by the user as follows:

- > Release the locking knob by turning it anti-clockwise
- > Lift the front of the shelf and tilt it slightly.

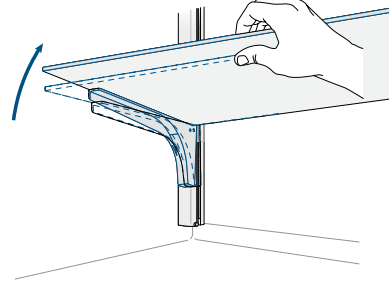

- > To remove a shelf, you must first slide it up and then take it out.

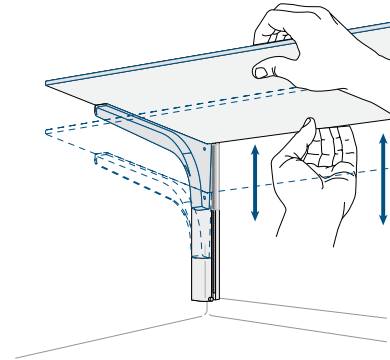

Door Bins

The door bins can be easily removed for cleaning.

- > Grasp the sides of the door shelves and push them upwards to release them from their seats, then pull them outwards.
- > Refit them operating in reverse order.

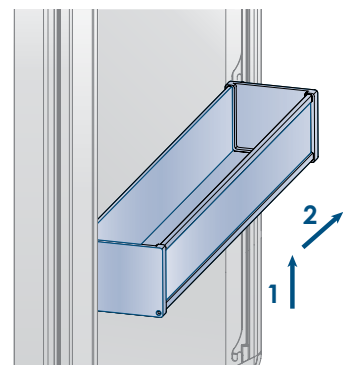



Careful, do not place hands or fingers near the Ice Maker when it is in operation.

8. ACTIVATING AND USING THE ICE MAKER

8.1. Activation and use of the Ice Maker



Notes

- > If the ice is not used frequently is advisable to empty the ice bin once every 8-10 days. If the ice is not frequently used, the older cubes can become opaque, will have a strange flavour and become smaller.
- > The Ice maker automatically switches off if the Vacation function  is activated.
- > When the Ice maker is started for the first time, do not use the first ice produced (dispose of the first bucket of ice)
- > If the appliance has been switched off for a month or more, it is recommended to perform a water  and filter  cleaning cycle.
- > The Ice maker produces ice only if the Fresh Select compartment is set to Freezer mode.



Warning

The Ice Maker will continue to operate even if the ice bin is not in position.

Activating/Deactivating the Ice maker

To activate the Ice maker after the installation of the appliance, 5) Ice maker activation/deactivation (only in Combi and Freezer models) on page 22. If the appliance is operating without being connected to the water system, make sure that the Ice maker is deactivated.

Productivity and cubes size

Once the Ice maker has been activated, it will take between 12 and 24 hours to have the automatic production of ice. Ice will be produced until the bin is full. Once the maximum allowed level is reached, production will stop automatically.

The production is 10 cubes about every two hours (for a total of 10 cycles over 24 hours).

The yield depends on the temperature set in the freezer, the ambient temperature and how frequently the door is opened.

With the **MAX ICE**  function, it is possible to increase the quantity of ice produced in 24 hours (up

to 1.5 kg (3.0 lbs.) a day) while with the **ICE SIZE**  function you can select the size of the cubes produced (see also chap. Setting the ice cubes size and Max Ice function on page 23).

Any problems encountered

Does the ice give off an unusual smell?

Ice is a porous material which can absorb odors from its surrounding environment. Ice cubes which have been in the ice cube container for a long time may absorb odours, stick together and slowly become smaller.

We recommend that old ice cubes not be used.

Other means of preventing odours:

- > **The ice cube container should be cleaned occasionally with warm water. Make sure that you switch off the ice maker before clearing the container. Rinse it out and wipe it dry.**
- > **Check the contents of the freezer for spoiled or out-of-date food. All odorous foods should be wrapped thoroughly or stored in airtight containers to prevent the odors from accumulating.**
- > **The water filter has to be replaced periodically.**
- > **In some cases the quality of the water connection in the house should be checked.**

Operating noises

- > **Hum:** the refrigerator unit is running. The fan in the air recirculation system is running.
- > **Bubbling, humming or gurgling noises:** refrigerant is flowing through the tubes.
- > **Clicking:** motor is switching on or off. Solenoid valve on the water connection is opening/closing.
- > **Rumbling:** ice cubes are falling into the ice cube container.



The Bottom-freezer model is powered by two independent compressors. It is therefore normal to always have one of the two compressors in operation.



Warning

Do not place any bottles or food in the ice cube container for rapid cooling. The ice maker may become blocked and be damaged.

8. ACTIVATING AND USING THE ICE MAKER

8.2. Internal water filter

The internal water filter ensures superb quality and purification of the water used for the production of ice cubes; its filtering duration is up to 3,000 litres (792,6 gal) and for a maximum time of 12 months.

Filter replacement

The filter is located inside the refrigerator compartment, above the top glass panel.

Before changing the filter, deactivate the Ice maker temporarily (see chap. 5) Ice maker activation/deactivation (only in Combi and Freezer models) on page 22.

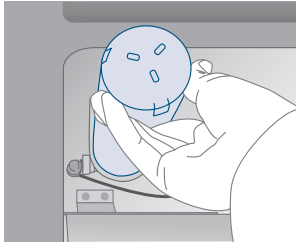

Pull both levers on the front of the glass to release the locking mechanism and pull the glass down, then carefully rotate the filter cartridge a quarter of a turn counterclockwise until it is released from its seat (it is normal for a small amount of water to come out). Remove the cap from the new cartridge and insert it in its housing by gently rotating it clockwise for one quarter rotation until it locks into place, without forcing it.

After replacing the filter

> **Clean the circuit following the instructions in chap. 8) Circuit manual cleaning (not on Refrigerator models) on page 25;**

> **Remove the water from the ice container and dry it.**

8.3. External water filter for freezer column Ice Maker

When the water filter needs replacing, the home screen will display an alert.

1. Remove the metal top guard that is held by magnets.
2. Rotate the old filter counterclockwise until it releases from the filter head, then pull the filter all the way out.
3. Remove the new filter from its box, remove all packaging, and insert the new filter in the filter head, then rotate it half a turn.
4. Reinstall the metal top guard.
5. Press Reset on the Water Filter icon to reset the water filter timer, then press Yes to confirm.

Filter activation/deactivation

See chap. 6) Water filter - activation on page 23.

If you choose NOT to use the water filter (for instance because the appliance is connected to an already filtered water source) then we suggest you disable the warning to avoid receiving reminders to change the filter (that you are not using).

For further details on how to access this function setting, follow the instructions in chap. 6a) Water filter - deactivation on page 24).

After every annual replacement of the water filter cartridge, it is necessary to reset the count of the quantity of filtered water and of the time elapsed since the last replacement following the instructions in chap. 6a) Reset Filter on page 24.

9.1. Compartment lighting

Bottom Freezer

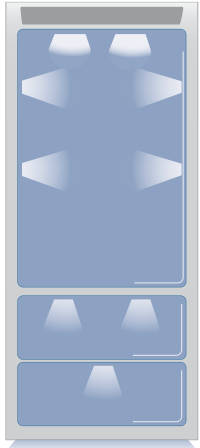

Freezer

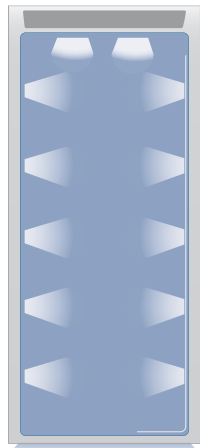

Refrigerator

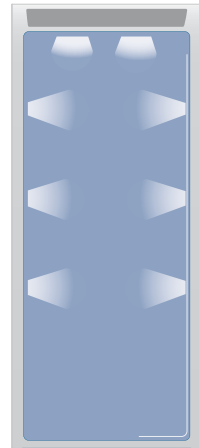

To provide optimum interior lighting, LED lights illuminate the refrigerator compartment from the top and sets of LED lights directly illuminate different areas of the refrigerator compartment, and the freezer drawer.

In case of malfunction and/or wearing out of the lighting system, the repair should be carried out by a qualified Viking Service technician.

10.1. General directions

Your appliance is designed to ensure constant accurate temperatures and appropriate humidity levels in all compartments. In addition, the double refrigeration ensures that frozen foods and ice do not absorb the odor of fresh foods and that the humidity in the refrigerator does not freeze, resulting in frost build-up.

Nevertheless, to properly preserve all of your foods, it is not enough to have an excellent refrigerator. It is also necessary to know the rules of correct cold food storage.

Bear in mind that all foods will inevitably change their characteristics with the passage of time. This change begins long before the food is consumed, since foods contain micro-organisms which multiply and can cause deterioration.

This process occurs more rapidly in the case of improper handling and of incorrect storage temperatures and humidity levels.

Follow the instructions provided below which will allow use of your refrigerator/freezer in the safest and most effective manner, to keep your foods in the best possible way for as long as possible.

Periodically check that all foods are in a proper state of preservation. It is usually quite clear when a food item has deteriorated, due to mold, an unsavoury odour and an unpleasant aspect. Nevertheless, there are cases in which these conditions are not so evident.

If you believe that a food item has been kept for an excessive period of time and may have deteriorated, do not consume this item or even taste it, even if it still seems to be well preserved, since the bacteria that cause deterioration in food can also cause poisoning and illness. When in doubt, throw the food away.

10. CONSERVATION OF FOODS

10.2. How to maintain good food quality

When buying groceries

Always take the following precautions:

- > Place packages containing raw meat, fish or poultry in containers suitable for food storage.
- > Buy meat, poultry and fish last. Do not leave your groceries in a warm car after shopping.
- > Keep a freezer bag in your car and use it in case of very high temperatures or long trips.
- > Check the production and expiration dates on foods to make sure they are fresh.
- > Buy fresh food in quantities that you can consume in 1-2 days.
- > Leave hot foods at room temperature for at least two hours before placing them in the refrigerator.

When placing foods in

Check the refrigeration temperature of the various compartments on the control panel:

- > Follow the recommendations regarding storage times and temperatures indicated in the tables below.
- > Keep raw meat, fish and poultry separate from other foods and avoid any possible drippings.
- > When placing in the refrigerator your meat, fish or poultry, leave these in their original packaging, unless the packaging is ripped or punctured.
- > Repeated handling could introduce bacteria into these foods.
- > To keep food in the freezer it is a good idea to use freezer containers.
- > Label and date the packages.
- > Be careful to correctly position the food items on the shelves in a way that does not obstruct the cold air circulation vents inside the compartment.



Warning

After a prolonged interruption of electrical power, once the electrical power is reactivated, an signal will indicate if the temperature has raised above normal levels. In addition to this the display will show for one minute the highest temperature detected inside the compartments, to allow the user to decide how to better use the food items.

10. CONSERVATION OF FOODS

10.3. Tips for food storage

Temperatures

The appliance working temperatures are set at the recommended degrees of +41°F (+5°C) for the refrigerator, 32°F (0°C) for Fresco drawers and 0°F (-18°C) for the freezer.

Food arrangement

Refrigerator compartment door bins:

- > Keep eggs, butter, cheese etc. in the upper and central parts.
- > Keep drinks, bottles, cans etc. in the lower part.

Refrigerator compartment:

- > Keep preserves, wine, biscuits etc. in the upper part.
- > Keep dairy products, pre-prepared foods, pastries, fruit juices, beer, etc. in the central part.

Upper drawer

- > Keep fresh fruit, tropical food, vegetables, carrots, potatoes, onions... Lower drawer
- > Keep meats, cold cuts etc...

Freezer compartment

We recommend you use the rear part of the upper basket for rapid freezing of products with the following indications:

- > Use small packs and if possible already cold.
- > The quantity of fresh food that can be frozen at the same time is described on the characteristic plate positioned in the cell.
- > Use special freezing bags, aluminium foil, food grade polyethylene film and freezing containers.
- > Do not use paper bags, cellophane bags not for food use, shopping bags or bags for freezing that have already been used.
- > Prevent frozen food coming into contact with fresh food to be frozen.

Food storage

- > Food must be stored in closed containers or properly packaged and must not emit or absorb odours and humidity.
- > Follow the recommendations regarding storage times and temperatures given in the table below.

10. CONSERVATION OF FOODS

FRESH FOODS	CONSERVATION AREA	TIME
Cooked meat		
Boiled and roasted meats	Refrigerator Compartment	2 days
Meat-based sauces	Refrigerator Compartment	6 days
Other		
Soups and broths	Refrigerator Compartment	2 days
Pasta	Refrigerator Compartment	2 days
Fresh cheeses	Refrigerator Compartment	2-3 days
Well protected aged cheeses	Refrigerator Compartment	Several months
Eggs (fresh and unwashed)	Refrigerator Compartment	2 weeks
Opened containers	Refrigerator Compartment	2-3 days
Raw vegetables (in perforated bags)	Refrigerator Compartment	1 week

FROZEN FOODS	CONSERVATION AREA	TIME
Beef, veal, lamb and goat	Freezer Compartment	(steaks) 6-12 months
Beef, veal, lamb and goat	Freezer Compartment	(Meat with bone in) 4-6 months
Ground beef	Freezer Compartment	1-2 months
Pork	Freezer Compartment	(Without bone) 4-6 months
Pork	Freezer Compartment	(With bone) 2-3 months
Ground pork	Freezer Compartment	1-2 months
Meat leftovers	Freezer Compartment	2-3 months

10. CONSERVATION OF FOODS

FROZEN FOODS	CONSERVATION AREA	TIME
Whole chicken and turkey	Freezer Compartment	8-12 months
Goose, duck and pheasant	Freezer Compartment	4-8 months
Fish	Freezer Compartment	1-2 months
Crustaceans	Freezer Compartment	2-3 months
Cooked foods	Freezer Compartment	1-2 months
Vegetables	Freezer Compartment	8-12 months
Fruit	Freezer Compartment	6-12 months
Desserts and cakes	Freezer Compartment	2-3 months

11. CARE AND CLEANING

11.1. Care and Cleaning

To clean parts and surfaces made of steel, use a microfiber cloth and the sponge provided in the kit with the appliance.

Always use the cloth and sponge in the direction of the steel's satin finish.

Every now and then, to polish the steel, wipe with a slightly damp microfibre cloth.

Do not use the sponge on aluminium parts, such as the handles and the edging on the glass shelves. Take special care to keep the ventilation openings in the appliance or in the cabinet that houses it free of obstructions.



Note

Clean the inside of the appliance with a cloth, soap and water.



Warning!

The use of chlorine-based cleaning products or other products that contain chlorine should be avoided (bleach, hypochlorite, etc.).

11.2. Internal cleaning

Clean the interior of the appliance and its removable parts by cleaning them with a solution of luke-warm water mixed with a small amount of dishwashing detergent.

Rinse and dry right away.

Do not use mechanical devices or other methods to speed up defrosting.



Warning!

The use of chlorine-based cleaning products or other products that contain chlorine should be avoided (bleach, hypochlorite, etc.).



Warning!

Do not use water on the electrical parts, lights or control panel.



Do not bring cold glass parts into contact with hot water.

Do not wash any parts of the refrigerator in a dishwashing machine since this could damage or irreparably deform the parts.

11. CARE AND CLEANING

11.3. Cleaning of the ventilation grill, filter and condenser

In order for the unit to operate correctly, the ventilation grill, filter and condenser must be cleaned periodically.

A reminder for this periodic cleaning, to be performed every 6 months, is provided through sound alerts and a notification shown on the display. To activate or deactivate this warning signal and display the time left to the next cleaning, see chap. "9) Maintenance" on page 31).

The condenser is located behind the lower front ventilation grille, (see page 43).

To clean it use a vacuum cleaner with a soft brush attachment at maximum power, sweeping it along the vent slits.

In the event of significant dust build up, the ventilation grill can be removed to allow a more thorough cleaning of the condenser. After cleaning the condenser, touch the **RESET** icon to rest the warning after 12 months' time.

If you do not want the warning cleaning signal of the condenser any more, touch the **OFF** icon (see chap. "9) Maintenance" on page 31).

11. CARE AND CLEANING

11.4. Condenser Cleaning

To clean the condenser follow the instructions:

- > Turn off the appliance by pressing the ON/OFF button  on the main control panel for approx 3 seconds.
- > Wait approx. 30 minutes, until the condenser cools down to ambient temperature.
- > Remove the removable grille under the door.

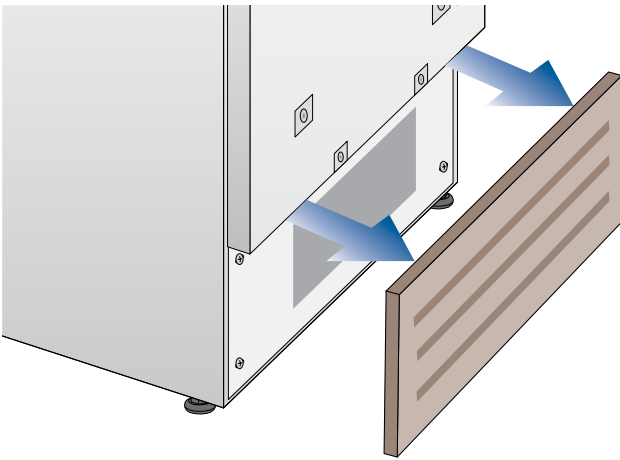

- > Clean the condenser thoroughly from all dust deposits as shown in the figure, taking care not to damage it.

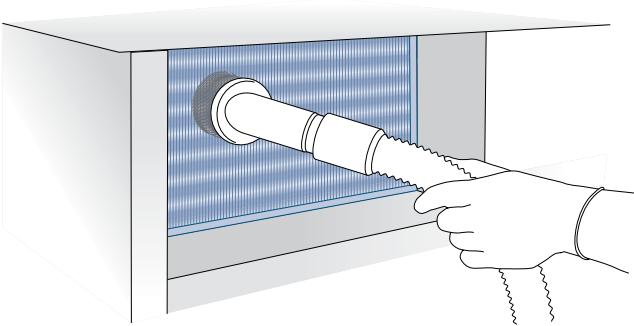

- > Restart the appliance acting on the **ON/OFF**  button again for about 3 seconds.



Warning!

The edges of the condenser are sharp, therefore use suitable protection for your hands and arms when cleaning the condenser.

12. TROUBLESHOOTING GUIDE

12.1. Troubleshooting Guide

If you notice any malfunctioning of your appliance, use this guide before calling for service. This guide can help you to solve the problem on your own or could provide important information that you can convey to the Service technician in order to ensure rapid and effective repair.

Display message and audible alarms.

A malfunction is usually indicated on the display. The problems that cannot be solved by the user are signaled through a malfunction code. Keep in mind, however, that these may appear in messages or alarms under particular conditions of use or during start-up. In such an event, deactivate the sound alert by pressing the **ALARM** (🔊) button, leave the appliance running and open the doors as infrequently as possible for 10-12 hours.

The refrigerator or the freezer does not work

Is the appliance connected to the electrical power supply?

Is electrical power being supplied from the electrical socket?

Is the **ON/OFF** (🔌) button activated?

Is the unit in '**DEMO**' mode? If you suspect your appliance is in **DEMO** mode, please contact your point of purchase for assistance with disabling this feature (see also page 31)

The refrigerator or the freezer is warmer than usual

Does the display show a malfunction code?

Is the temperature adjusted correctly?

Were the doors or drawers open for a long period of time?

Were large quantities of food recently placed inside?

Is the unit in '**DEMO**' mode? If you suspect your appliance is in **DEMO** mode, please contact your point of purchase for assistance with disabling this feature (see also page 31)

The compressor is on for a long time period

Bear in mind that during very hot weather and with very high temperatures in the room it is normal for the compressor to remain on for extended periods of time.

Were the doors or drawers open for a long period of time?

Were large quantities of food recently placed inside? Check that the doors are closed and that the food or containers do not obstruct the perfect closure of the door.

Are one or more of the compartments in **SHOP-**

PING mode? (see page 20)

If you hear strange noises

It is normal to hear noise from the fans or compressors during the defrost phase. Noise could be more marked depending on the position of the appliance and the surrounding environment.

Condensation inside and outside of the refrigerator

If the climate is very humid, the formation of condensation is normal. Opening the door or drawers for extended periods of time can contribute to the formation of condensation.

In any case, make sure that the doors are always fully closed.

Ice or frost build up inside the refrigerator or freezer

Did you leave the doors open for a long period of time?

Are the doors closing completely? If the doors do not fully close, check the placement of the products inside the compartment. Contact your installer. In case of frost or ice build up in the Crisper-Fresco compartment, due to frequent and prolonged opening of the doors, deactivate the Crisper-Fresco function via the button on the control panel. Wait until the frost or ice melt, then remove the drawer and dry the sides and bottom of the compartment.

Unpleasant odours inside the refrigerator

Clean the appliance thoroughly according to the instructions. Hermetically cover all of the food. Do not store food for extended periods of time.

The doors are difficult to open

The appliance was designed to permit hermetic closure. When the door is closed, a vacuum condition can be created: in such an event, it is necessary to wait a few seconds until the pressure balances before opening the door.

The appliance is cooling but lights and display are not working

Check to see if the appliance was accidentally put into **SABBATH** mode (see page 30).

The Ice Maker does not work

Make sure that the Ice Maker is on (🧊 icon).

12. TROUBLESHOOTING GUIDE

To turn it on, see chap. 5) Ice maker activation/deactivation (only in Combi and Freezer models).

Make sure that the appliance is connected to the water supply.

If the filter has not been replaced for a long time, the water flow may be limited.

The Ice Maker does not produce sufficient amounts of ice

On average, the production is about 10 cubes every two hours (for a total of 10 cycles over 24 hours).

The ice cubes freeze into one block

If the ice is not used frequently, it is possible that blocks of ice may form. It is recommended that you remove the block of ice cubes and then let the Ice Maker fill the ice tray again.

The ice has an unusual flavor or color

When the Ice maker is started for the first time, do not use the first ice produced (dispose of the first bucket of ice)

If the refrigerator was switched off for more than one month or if the cartridge was not changed for more than six months, it could be necessary to replace the filter cartridge.



Contact a plumber or a water treatment expert to make sure that the problem is not due to the water supply.





If the unit you purchased was used as a showroom model, it may be in a special energy-saving mode called Demo Mode, in which the appliance appears to be operating (lights work and false temperatures are displayed) but no cooling actually takes place. If you suspect your appliance is in Demo mode, please contact your point of purchase for assistance with disabling this feature (see also page 31)

12. TROUBLESHOOTING GUIDE

12.2. Malfunction messages appearing on the display

- > In the event of a malfunction, touch the **ALARM**  button and the display will show the fault message with its error code (see following table).
- > The message will be shown for 3 seconds, then it will go back to the HOME screen.
- > To block the message on the screen, press the **INFO** button  on the display. The message will remain on the screen for 30 seconds, then it will go back to the HOME screen.
- > In the event that there is more than one error message, the display will show the different fault messages in chronological order.

Display message	Malfunction description
Power Failure!!	Extended interruption of electrical power The appliance starts up again automatically and indicates the highest recorded temperatures. Press the ALARM  button to deactivate the sound alarm
Upper unit open	Refrigerator door open This message appears when the door has been open for a few minutes.
Lower unit open	Freezer door open This message appears when the door has been open for a few minutes.
Replace filter	Replace water filter cartridge message appears: every 12 months after the reset
Upper unit too warm	Refrigerator too warm See Troubleshooting Guide
Upper unit too cold	Refrigerator too cold wait for 12 hours: if the malfunction persists, call Customer Service for advice.
Lower unit too warm	Freezer too warm See Troubleshooting Guide
Lower unit too cold	Freezer too cold wait for 12 hours: if the malfunction persists, call Customer Service for advice.
Error Code...	Functional problems Contact Customer Support. Check the conditions of use (high food loads, frequent door opening). Press the ALARM  button to deactivate the sound alarm.
Check condenser	Check Condenser Every 6 months the display shows the message " CHECK COND. ", clean the condenser and press and hold the ENTER button  for 5 seconds to reset.

Viking Range, LLC
111 Front Street
Greenwood, Mississippi 38930 USA (662) 455-1200

For product information, call 1-888-(845-4641)
or visit the our web site at vikingrange.com