

Dishwasher

KoolMore Top Control Dishwasher

Model:

KM-DW2445-PR

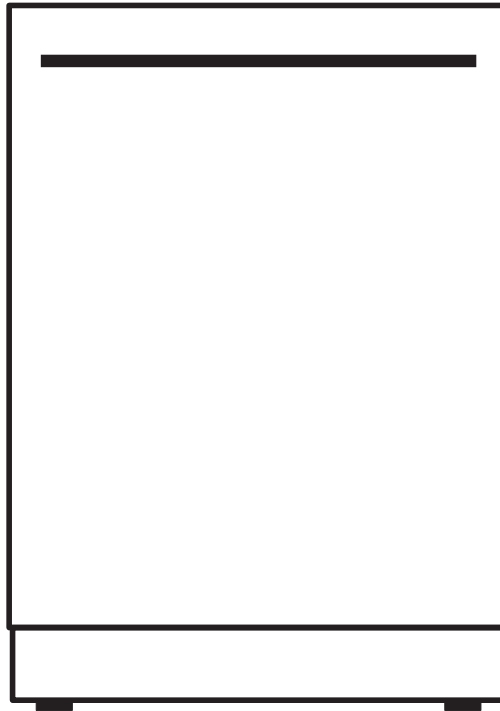

Before using, please read the operating instructions carefully to ensure proper application and achieve satisfactory results.

For any service-related issues, please contact us:



718-576-6342



support@koolmore.com

CONTENTS

Please carefully read this manual before using the dishwasher, it will help you use and maintain the dishwasher properly .

SAFTEY	2
PACKAGE CONTENTS.....	3
INSTALLING.....	4
FEATURES.....	4
USER MAINTANANCE.....	17
TROUBLESHOOTING.....	21
WARRENTY.....	25

SAFETY

▲ CAUTION ▲
RISK OF ELECTRIC SHOCK
DO NOT OPEN

This symbol indicates that dangerous voltage constituting a risk of electric shock is present within your dishwasher.

This symbol indicates that there are important operating and maintenance instructions in the literature accompanying your dishwasher.

WARNING - When using your dishwasher, follow basic safety precautions, including the following:

1. Read these instructions.
2. Keep these instructions.
3. Heed all warnings.
4. Follow all instructions.
5. Clean only with a damp cloth.
6. Do not block any ventilation openings. Install in accordance with the manufacturer's instructions.
7. Make sure that the available AC power matches the voltage requirements of this appliance.
8. Refer all servicing to qualified service personnel. Servicing is required when the appliance has been damaged in any way or it does not operate normally.

WARNING

Electric Shock Hazard

Failure to follow these instructions can result in electric shock, fire, or death.

WARNING-DANGER —Never allow children to play with, operate, or crawl inside the dishwasher.

Turn off the dishwasher before carrying out user maintenance on it.

If a component part is damaged, it must be replaced by the manufacturer, its service agent, or similar qualified persons in order to avoid a hazard.

This appliance is intended to be used in household and similar environments.

Basic precautions before use:

- Read all instructions before using the dishwasher.
- The manual does not cover every possible condition and situation that may occur.
- Use the dishwasher only for intended function as described in this manual.
- When loading items to be washed:

Load sharp items and knives so that they are not likely to damage the door seal and tub.

Load sharp items and knives with the handles up to reduce the risk of cut-type injury.

- Do not wash plastic items unless they are marked dishwasher safe or the equivalent, if not marked, check with manufacture for recommendation, items that are not dishwasher safe may melt and create a potential fire hazard.
- If the dishwasher drains into a garbage disposal, make sure disposal is completely empty before running dishwasher.
- Do not tamper with the controls.
- Do not operate your dishwasher unless all enclosure panels are properly in place.
- Do not touch the heating element during or immediately after use, especially if the sanitize option has been selected.
- Do not let children abuse, sit, or stand on door or racks of the dishwasher.
- Under certain conditions, hydrogen gas may be produced in a hot water system that has not been used for two weeks or more. HYDROGEN GAS IS EXPLOSIVE. If the hot water system has not been used for such a period, before using one hot water faucet and let water flow from each for several minutes. This will release any accumulated hydrogen gas. Hydrogen gas is flammable. Do not smoke or use an open flame during this time.

- Do not store or use combustible materials, gasoline or other flammable vapors and liquids in the vicinity of this or any other appliance.
- Use only detergents or rinse agents recommended for use in a dishwasher and keep them out of the reach of children.
- Keep young children and infants away from dishwasher when it is operating.
- Do not use the dishwasher if it has a damaged power line or plug, and do not plug the dishwasher into a damaged outlet, failure to observe these instructions may result in electrical shock.
- Remove the door to the washing compartment when removing an old dishwasher from service or discarding it.
- To reduce the risk of injury, do not allow children to play in or on a dishwasher.

SAVE THESE INSTRUCTIONS

PACKAGE CONTENTS

- Dishwasher
- Hose
- Installation kits
- User Guide
- Installation Guide

Main components

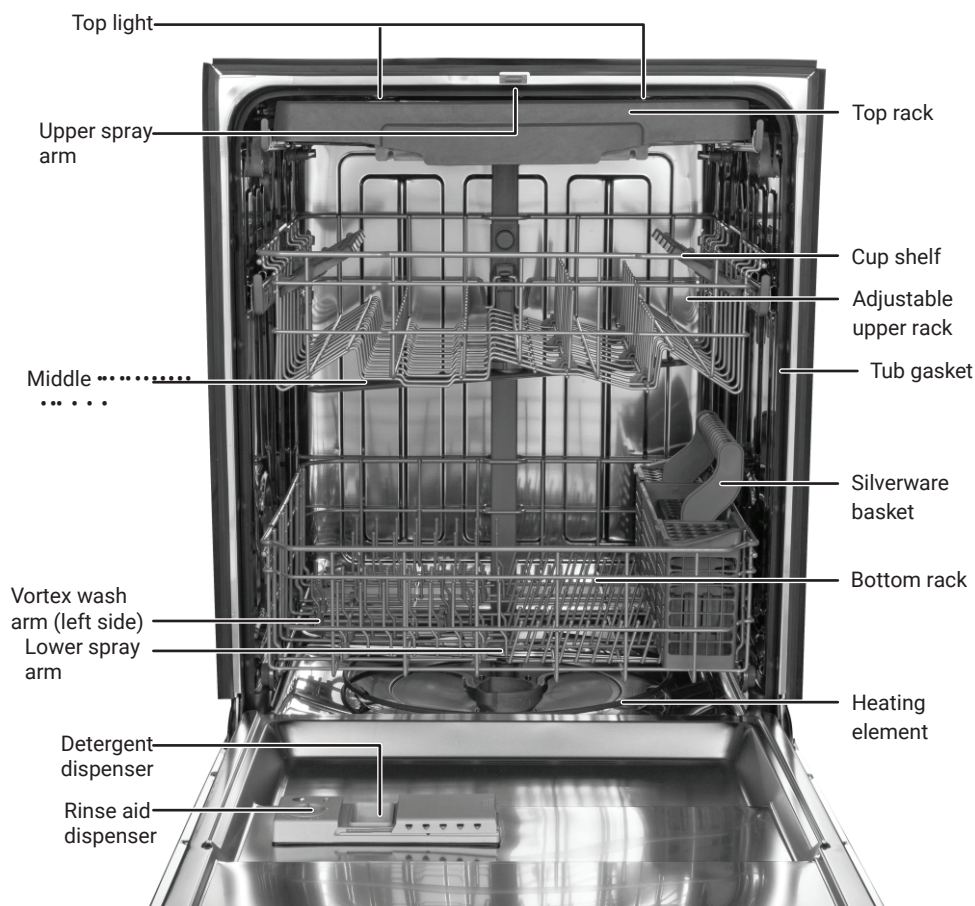

Installing and setting up your dishwasher

Water supply temperature should be between 120°F and 149°F .

Dispose of the discarded appliance and packing material properly.

The dishwasher must be grounded or it can result in a risk of electric shock.

If there is any damage to the contact to the dishwasher, please contact Customer Service. Do not attempt to repair or replace any part by yourself.

For information on installing and setting up your dishwasher, refer to the Installation Guide provided.

Before using your dishwasher

Remove the interior packing.

Clean the interior surface with lukewarm water using a soft cloth.

Finding a suitable location

This dishwasher is designed to be built-in.

The dishwasher door must be able to swing fully open.

Providing a proper power supply

Check your local power source. This dishwasher requires a 120V, 60Hz power supply. Refer to the Installation Guide for additional information.

Understanding your dishwasher's features

How your dishwasher cleans

The dishwasher fills with water, covering the filter area at the bottom. Water is then pumped through the various filter and spray arms, spraying a mixture of hot water and detergent against the soiled surfaces of your dishes and silverware. Soil particles are separated and go down the drain as the dirty water is drained and replaced with clean water. The number of water fills is determined by the cycle selected.

Cycle selections

Cycle times are approximate and will vary with options selected. Hot water is necessary to activate dishwasher detergent and melt fatty food soils. An automatic sensor checks the incoming water temperature and, if it is not hot enough, the timer will be delayed to allow for the water to heat to the main wash of all cycles. This helps even when hot-water heat is selected, so that higher temperature will be available to handle heavier soil loads.

Filter system

Your dishwasher has a multiple filter system which includes four separate filter meshes. It separates dirty water and clean water into different chambers. The multiple filter system helps your dishwasher to get better performance with less water and less energy.

Smart wash system

Your dishwasher has a smart wash system under the normal wash program which selects the wash cycle based on how large and how soiled the load, permitting your dishwasher to clean more efficiently every time. When a partial load of lightly soiled dishes is placed in the unit, a short wash cycle is automatically selected. When a full load of heavily soiled dishes is placed in the unit, a heavy wash cycle is automatically selected.

Adjustable upper rack

The upper rack of your dishwasher can be raised or lowered to accommodate loading dishes of varying heights in either rack. After removing the 3rd rack, the upper rack clearance height can be adjusted from 8" to 10". The lower rack clearance height can be adjusted from 11" to 13".

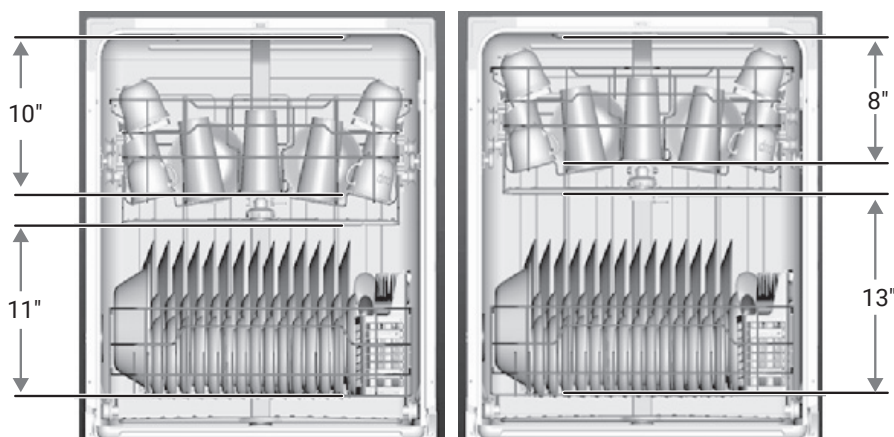

Using your dishwasher

Using the control panel

Your dishwasher's control panel is located on the top edge of the door. The door must be opened to make settings and operate the dishwasher.

Cycles

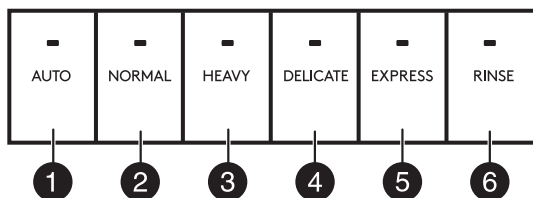

Select a cycle based on the type of dishes to be washed and the level of soil on the dishes.

Cycle times are approximate and will vary with options selected. The timer will be delayed to allow the water to heat to the main wash water level if the selected temperature is not hot enough. Below is the wash cycle times under standard conditions.

CYCLE	DESCRIPTION	WATER USE	CYCLE TIME (MINUTES)
AUTO	Auto sensing wash, light, or heavy soiled cooking, with or without detergent.	3.0 - 5.9 gal	100 - 133
NORMAL	Use for regularly soiled dinner dishes or silverware.	3.0 - 5.9 gal	102 - 120
HEAVY	Use for hard-to-clean, heavily-soiled dishes, pots, and cookware.	6.9 gal.	138
DELICATE	Use for lightly soiled and pre-rinsed dishes and glassware.	5.9 gal.	114
EXPRESS	Use for heavily soiled and pre-rinsed dishes and glassware.	4.9 gal.	60
RINSE	Use for pre-rinsing dishes or glasses. This is only a rinse that removes food from the dishes. It can fast track your next load by up to 70% if dishes are not heavily soiled with a full load. Do not use detergent.	0.7 gal.	20

Controls and indicators

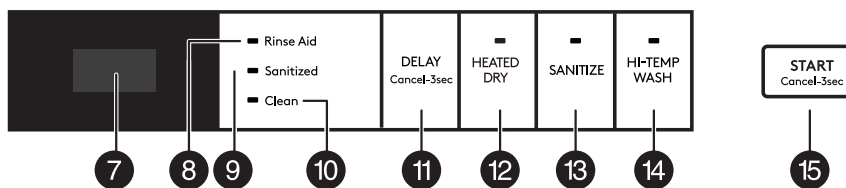

Options can add enhancements to the cycle selected.

DISPLAY—Shows the remaining hours and minutes of the current cycle, delay hours remaining, and error codes .

Rinse Aid—Turns on when you need to add rinse aid. Turns off when the sanitized cycle is finished.

Sanitized—Turns on when a sanitized cycle is finished. Turns off when the door is opened and remains off if the unit has been operated and closed within 60 seconds.

Clean—Turns off after a cycle finished. Turns off when the door is opened above 60 seconds or any button operated and close the door during 60 seconds.

DELAY—Press repeatedly to delay the start of the selected wash cycle until the delay time you want is shown on the display. You can select from one to 24 hours delay. After you select the delay time you want, press **START/CANCEL** once, then close the door within four seconds. The delay begins to count down. If you open the door while delay is running, press the **START/CANCEL** , then close the door within four seconds to begin the cycle from that point. To cancel the delay and begin the cycle before the delay period is complete, open the door, then press and hold **DELAY** for three seconds.

START/CANCEL—Press to start the dishwasher after you have selected a cycle and function (if desired). Close the door. The cycle indicator begins to blink and the function indicator turns on. If you close door without pressing **START/CANCEL** or don't close door within four seconds of pressing **START/CANCEL** , the dishwasher pauses, without any open and close door operation, the dishwasher then returns to standby status. Press **START/CANCEL** again to continue with the cycle.

To cancel a running cycle, open the door, then press and hold **START/CANCEL** for three seconds. The dishwasher will return to standby status. To add more dishes or pause the dishwasher while it's already running, open the door. A safety mechanism stops the cycle.

Caution

To avoid injury open the door slowly and carefully. There is a possibility of hot steam from inside the dishwasher.

You can add more dishes before the main wash cycle has started. To determine this, check the detergent dispenser in the door. If the detergent dispenser is still closed, you can add more dishes. If it is open, you can add dishes to the dishwasher if the dish quantity is small. If the quantity is large, restart the cycle.

Options

12 - HEATED DRY—Use to heat-dry your dishes. This function is not available for rinse only cycle.

13 - SANITIZE—Use to sanitize your dishes and glassware. Maintains the water temperature at 158°F max., and is available with the AUTO, NORMAL, and HEAVY cycles.

Notes

- Certified residential dishwashers are not intended for licensed food establishments.
- The sanitize cycle is NSF certified.

14 - HI TEMP WASH—Use to maintain the water temperature at 135°F max. This option is available with the AUTO, NORMAL, and HEAVY cycles.

Basic operation

1. Load the dishwasher.
2. Add detergent.
3. Add rinse aid, if needed.
4. Select the cycle you want. The indicator will light when the selection is made.
5. Select the function you want. The indicator will light when the selection is made.
6. To start, press START/CANCEL on the control pad.
7. Close the door within four seconds and the wash cycle will begin.

Preparing and loading dishes

Preparing dishes for washing

- Scrape away large pieces of food, bones, pits, toothpicks, and similar items. The continuous filtered wash system will remove the remaining food particles.



- Burned-on foods should be loosened before loading.
- Empty liquids from glasses and cups.
- Foods such as mustard, mayonnaise, vinegar, lemon juice, and tomato-based products may cause discoloration of stainless steel and plastics if allowed to sit for a long period of time. Unless the dishwasher is to be operated at once, it is best to rinse off these types of foods.
- If the dishwasher drains into a garbage disposal, be sure the disposal is completely empty before starting dishwasher.

Loading the top rack

You can place the items in the top rack randomly or in an orderly fashion. The image below shows how to load the top rack for 14 place settings:

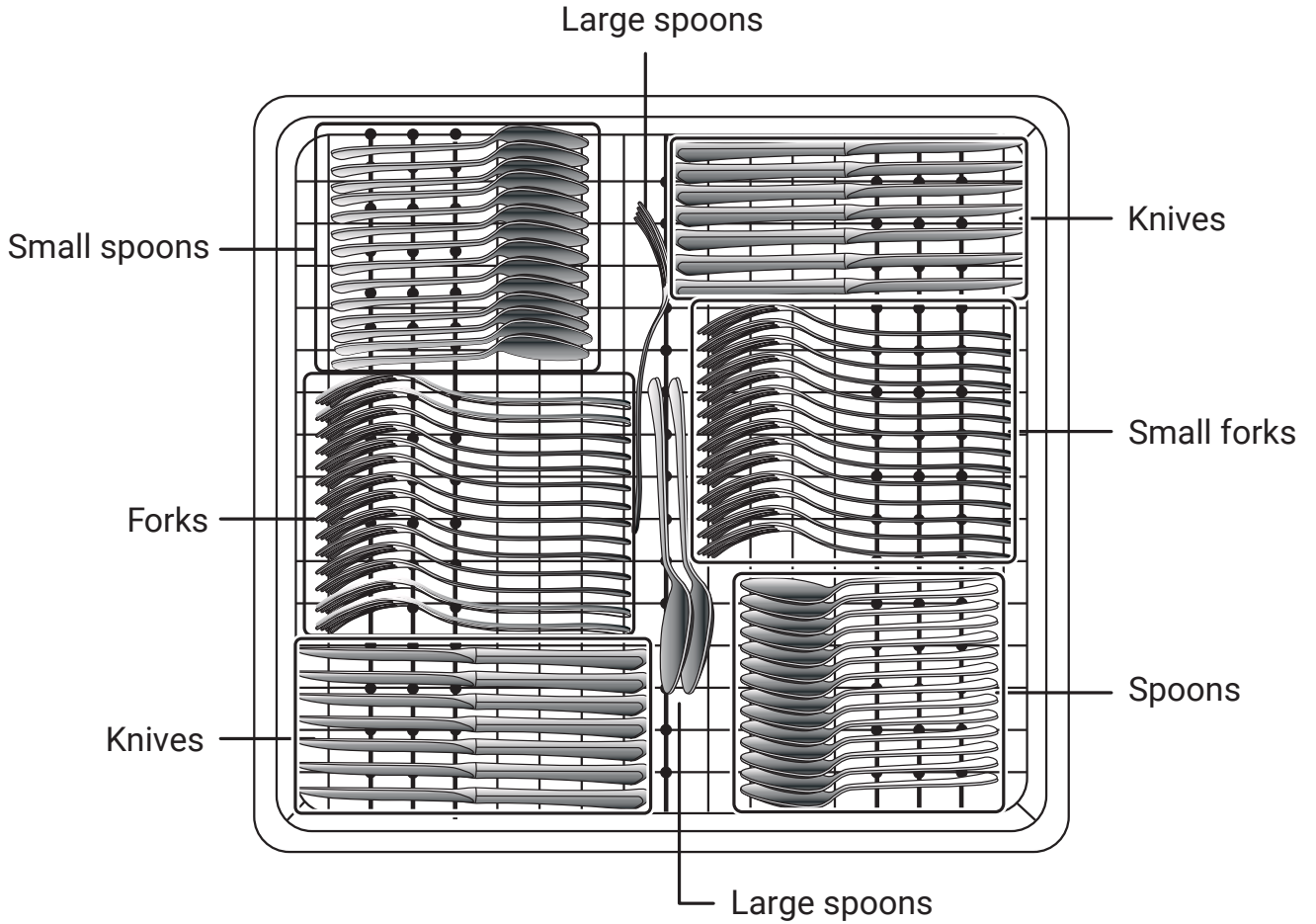

Adjusting the upper rack

The height of the upper rack can be adjusted to accommodate loading taller dishes in either rack.

- 1 Lift the rack to move it to the upper position.

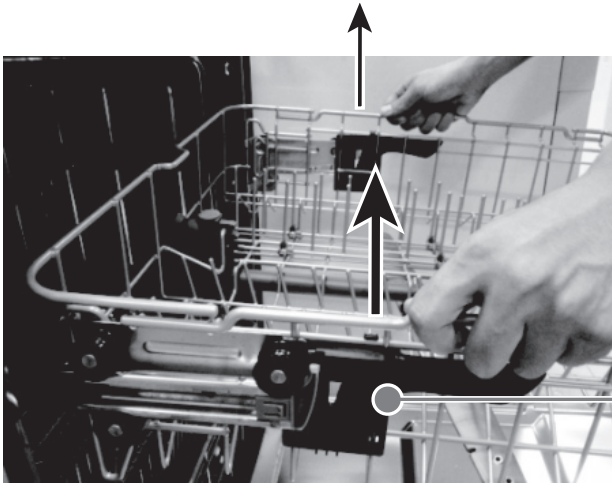

Upper rack in the upper position

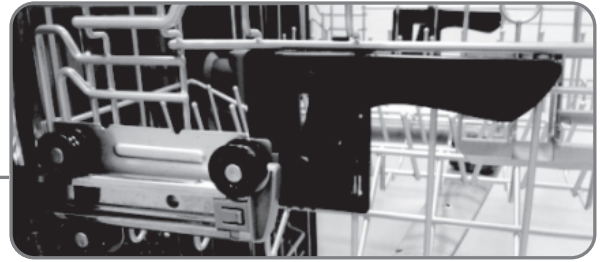

- 2 Press the handle to move it to the lower position.



Upper rack in the Lower position



Loading the upper rack

The upper rack is designed for cups, glasses, small plates, bowls, and plastic items marked dishwasher-safe. For best results, place the items with the soiled surface facing down or toward the center. Tilt them slightly for better drainage.

Notes

Make sure the loaded dishes do not interfere with the rotation of the middle spray arm, which is located just below the upper rack. You can check this by rotating the middle spray arm by hand.

Loading suggestions are shown below:

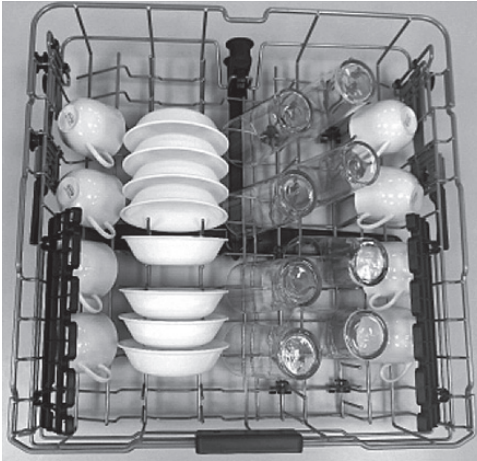

8 place settings

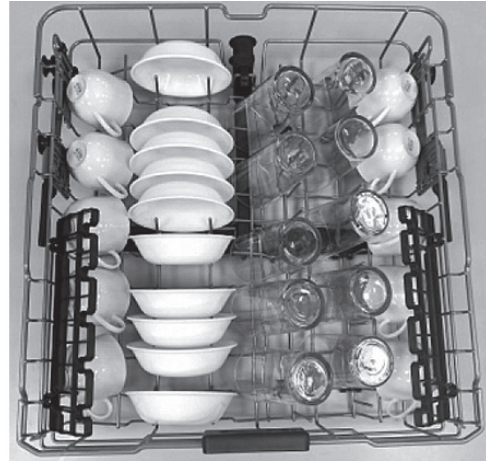

10 place settings



12 place settings

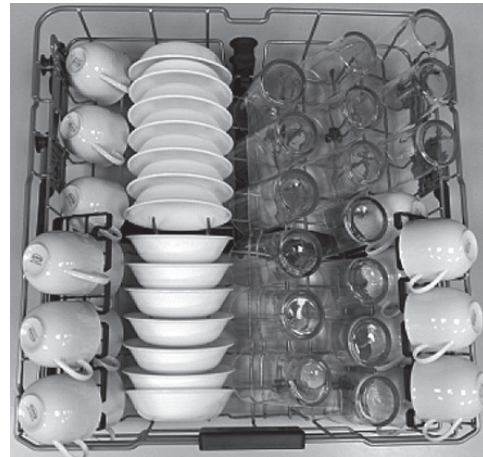

16 place settings

Loading the bottom rack

The bottom rack is designed to accommodate plates, bowls, saucers, and cookware. The adjustable rack lets you load items up to 13 inches high. Large items should be placed along the edge, with the inside faces down, so they do not interfere with the middle or lower spray arms or prevent the detergent dispenser from opening.

The fold-down tines on the bottom rack are provided to support extra large and hard-to-fit items. The tines may be left up for normal use or folded down for more flexible loading of larger items.

Loading suggestions are shown below:



8 place settings

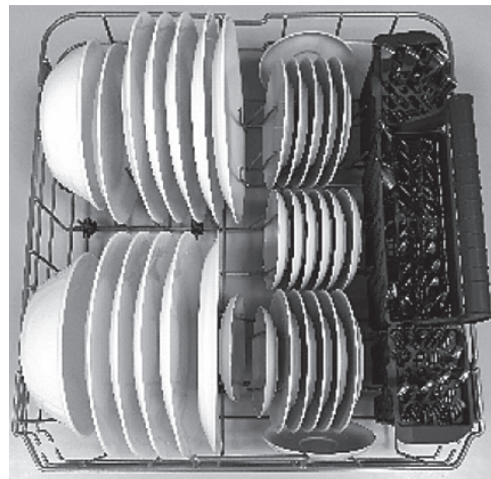

10 place settings

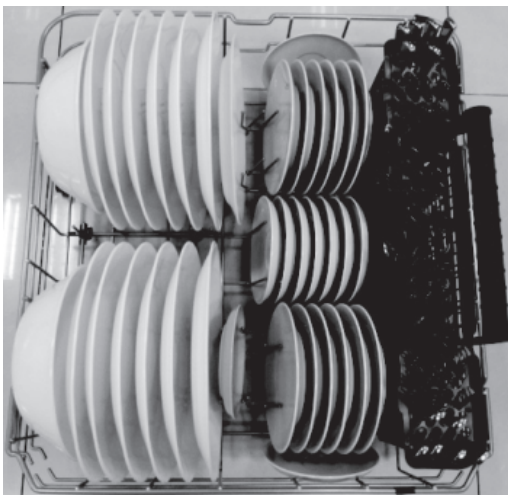

12 place settings

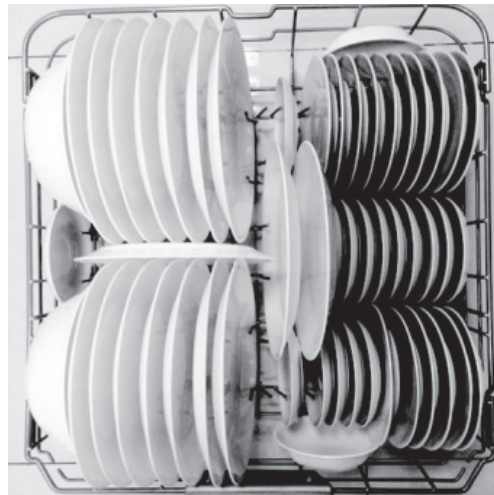

16 place settings

Loading the silverware basket

The silverware basket is divided into three separate sections, which can be placed in either the upper or lower racks.

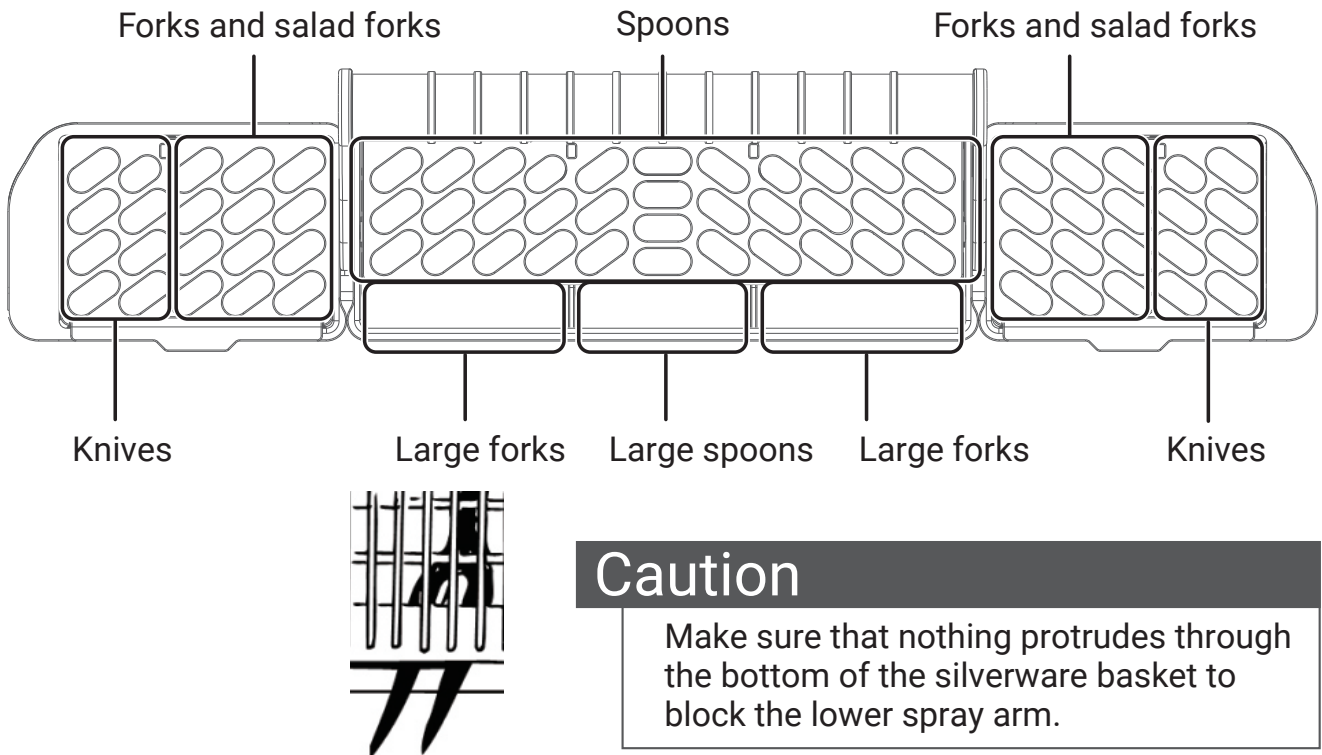

Adding a dish

Caution

TO AVOID BURN INJURY: Open the door slowly and wait until the spray arms and wash action stop. Hot water may splash out of dishwasher. Failure to do so may result in injury.

- 1 Open the door slightly and wait a few seconds until wash action stops before completely opening.
- 2 Add the item.
- 3 Press **START/CANCEL** on the control pad and close the door within four seconds. The cycle automatically resumes.

Filling the detergent dispenser

- 1 Push the detergent dispenser cover latch downwards to open the detergent cup.

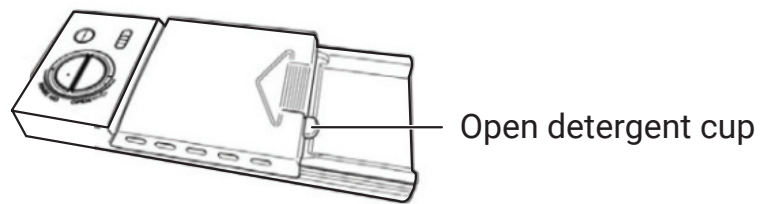

- 2 Add detergent (dry powder, liquid, or packets) to the cup.

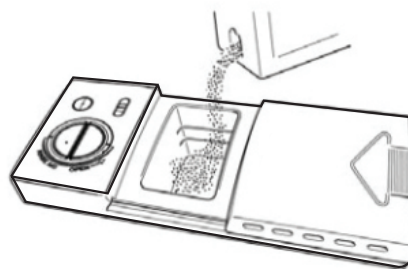

- 3 Close the detergent dispenser cover.

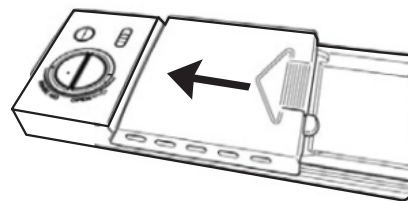

The amount of detergent required depends on the cycle selected and the soil level on the dishes. Refer to the following table for the recommended amount.

Cycle	Soft Water (0-3 grains)	Medium Hard Water (4-8 grains)	Hard Water (9-12 grains)	Very Hard Water (over 12 grains)
AUTO NORMAL HEAVY DELICATE EXPRESS	2 tsp. (main wash cup 1/4 full)	5 tsp. (main wash cup fill to line above regular)	8 tsp. (main wash cup completely full)	Main wash cup completely full (water softener recommended)
Rinse	No detergent	No detergent	No detergent	No detergent

Filling the rinse aid dispenser

Your dishwasher is designed to use a liquid rinse aid. The use of rinse aid greatly improves drying performance after the final rinse. Do not use a solid or bar-type rinse aid. Under normal conditions, the rinse aid will last approximately one month. Try to keep the dispenser full, but do not over fill it.

- 1 Turn rinse aid dispenser cap 1/4 turn counterclockwise and lift it out.

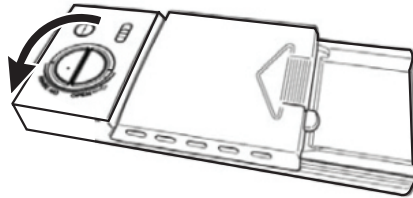

- 2 Add rinse aid until liquid touches the indicated fill level. Do not overfill since this can cause over sudsing. Wipe up any spills with a damp cloth. The dispenser holds enough for 35 to 140 washes, depending on the dial setting.

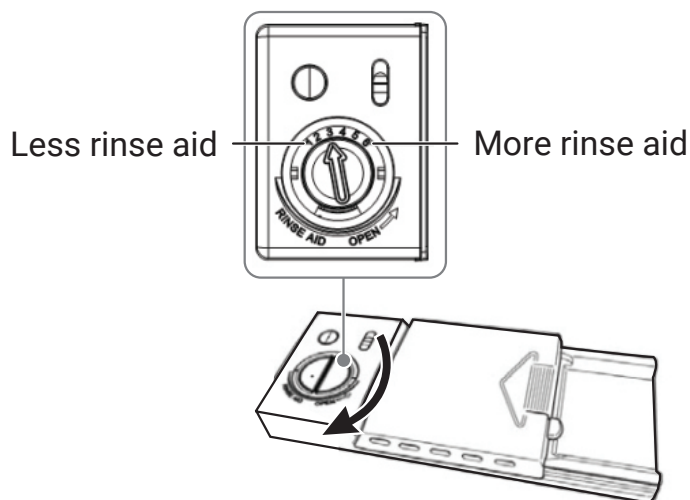
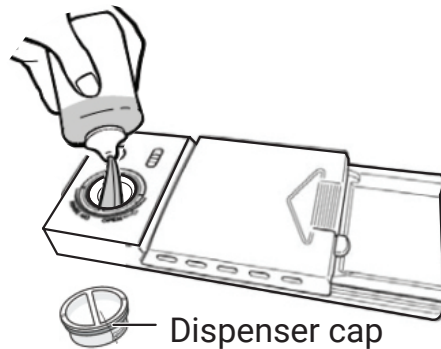

- 3 Replace the cap and turn it 1/4 turn clockwise.

USER MAINTANANCE

Factors affecting performance

Using rinse aid

- Rinse aid enhances drying and decreases water spots and filming.
- Without it, your dishes and the interior of the dishwasher might retain excessive moisture.
- The dishwasher won't perform optimally without rinse aid.
- The unit dispenses a set amount of rinse aid during the last rinse.
- If dishes are spotty or poorly dried, increase the amount of rinse aid by adjusting the dial located under the dispenser cap.
- When the rinse aid level is low, the rinse aid light will come on at the start and end of the cycle.

Water temperature

For the best dishwashing and drying, the water entering the dishwasher should be at least 120°F.

Test the water temperature by:

1. Running the hot water faucet near the dishwasher.
2. Using a thermometer (like a candy or meat thermometer) to check the water temperature. If it is below 120°F, have a professional adjust the hot water heater thermostat.

Important Note

Ensure that the water entering the dishwasher is hot. Run the nearest hot water faucet to clear out cold water before starting a cycle.

Heat dry function

This function, especially when combined with rinse aid, enhances drying.

If you don't choose the heat dry function, some items may remain damp at the cycle's end.

Water pressure

For optimal performance, ensure the hot water supply for the dishwasher has a pressure of at least 20 psi and not more than 120 psi.

If your water pressure is too low, especially during peak demand times or when other water-intensive appliances are running, wait until the demand decreases before starting the dishwasher.

2 Rotate the cylinder filter, then lift it out.

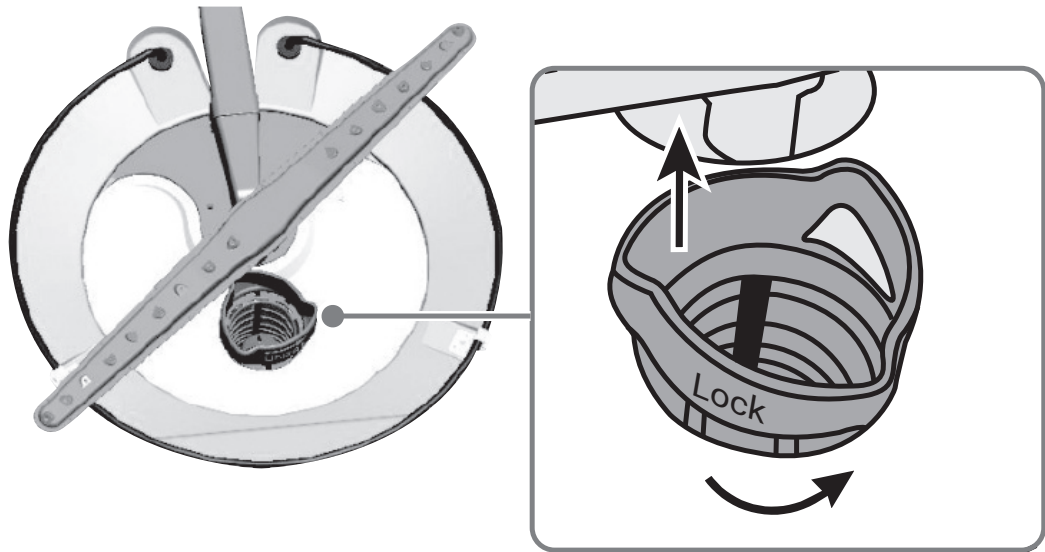

3 Lift the fine filter from the bottom of the tub.

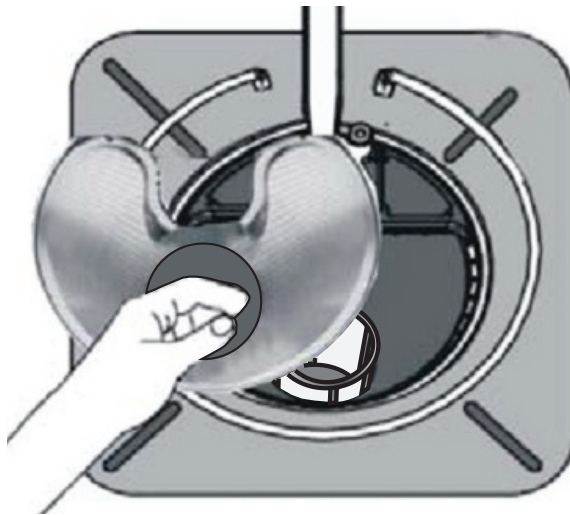

4 Take out the fabric filter.

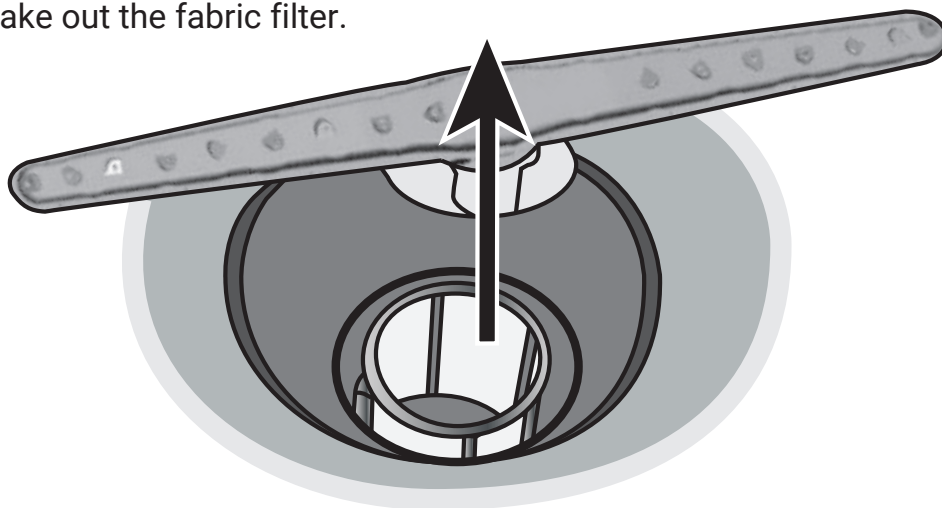

5 Flush the filters by holding them under running water.



6 Replace the fabric filter.

7 Replace the fine filter.

8 Replace the cylinder filter.

9 Replace the bottom rack.

Cleaning the door and tub gaskets

Clean the door gasket with a damp cloth to remove food particles regularly.



The inside of the dishwasher is self-cleaning under normal use. If needed, the tub gasket can be cleaned with a damp cloth. Use a brush to clean the opening in the end of the gasket.



Cleaning the air gap

If there is an air gap installed with your dishwasher, make sure it is clean so the dishwasher will drain properly. Air gap is not part of your dishwasher. Before you clean the air gap, turn off the dishwasher, then remove the plastic air gap cover and clean with a toothpick.

Protecting your dishwasher for long periods

Your dishwasher should be protected from freezing if you plan to leave it for extended periods in an unheated place. Have a qualified person do the following:

To disconnect service:

- 1 Turn off the electrical power to the dishwasher at the supply source by moving fuses or tripping circuit breaker.
- 2 Turn off the water supply.

3 Place a pan under the inlet valve, then disconnect water line from the inlet valve and drain it into a pan.

4 Disconnect drain line from pump and drain the water into a pan.

To restore service:

1 Reconnect the water, drain, and electrical power.

2 Turn on water and electrical power supply.

3 Fill the detergent cup and the rinse aid cup and run the dishwasher through a heated-wash cycle.

4 Check all connections to make sure they do not leak.

TROUBLESHOOTING

Refer to this table to correct minor issues before calling for service.

Error codes

CODE	MEANING	POSSIBLE CAUSE
E1	Longer inlet time	<ul style="list-style-type: none">• Faucet is not opened• Water intake is restricted• Water pressure is too low
E4	Overflow	A leak in the dishwasher
Ed	Communication exception or issue	The display board can't receive or the main board can't send a signal for over 20 seconds

Caution

- If an overflow occurs, turn off the main water supply before calling for service.
- If there is water in the base pan because of an overflow or small leak, the water should be removed before restarting the dishwasher.

PROBLEM	POSSIBLE CAUSE	POSSIBLE SOLUTION
The dishwasher won't start	The door may not be closed properly.	Make sure that the door is closed and latched.
	The power is off or not connected.	Make sure that the power is connected and turned on.
	The delay start option is selected.	Refer to the "Delay" section under "Controls and Indicators"
	The child lock is activated.	Deactivate the child lock.
The dishwasher beeps at the end of the cycle	This is normal and indicates that the wash cycle is complete.	-
The rinse and light is on	The rinse aid level is low.	Add rinse aid.
The dishwasher runs too long	The dishwasher is connected to a cold water supply.	Make sure that the dishwasher is connected to a hot water supply, if not, change the water supply to a hot water source.
	The cycle time varies, depending on the soil level of the dishes.	When heavy soil is detected, the wash times will be longer.
	Depends on the option selected.	Some options will add time to the cycle.
The dishes are not clean enough	The water pressure is too low.	Make sure that the water pressure is above 20 psi. Use your dishwasher when water demand is low.
	The inlet water temperature is too low.	Make sure that the dishwasher is connected to a hot water supply. If not, change the water supply to a hot water source. If you've done this already, ensure the water temperature is low.
	Dishes are too close together.	Reload the dishwasher
	Improper use of detergent.	Add detergent depending on the water hardness and washing cycle you choose. Use fresh detergent.
	The selected cycle is not suitable for the soil level on the dishes.	Choose a different cycle with a longer washing time.
	The spray arms are blocked.	Make sure that the spray arms are not blocked and are free to rotate.
The dishes are not drying enough	The rinse aid dispenser is empty or the setting is too low.	Fill the rinse aid dispenser. Increase the rinse aid setting.
	Dishes are loaded improperly.	Reload the dishes
	The cycle you chose did not include drying.	Choose a cycle with drying.

PROBLEM	POSSIBLE CAUSE	POSSIBLE SOLUTION
Spots and filming on dishes	Water hardness is too high.	For extremely hard water, install a water softener.
	Dishes are loaded improperly.	Reload the dishwasher as shown in "Preparing and loading dishes"
	Old or damp rinse aid is being used.	Use fresh, liquid rinse aid.
	The rinse aid dispenser is empty or the setting is too low.	Fill the rinse aid dispenser. Increase the rinse aid setting.
Etching	Using too much detergent.	Use less detergent if you have soft water.
	The inlet water temperature exceeds 150°F	Lower the inlet water temperature.
Detergent left in dispenser cup	Detergent may be too old.	Use fresh detergent.
	The spray arm is blocked.	When you load the dishes, make sure that the spray arms are not blocked.
The detergent dispenser will not close	Improper operation of the detergent cover.	Add detergent and rinse aid only as indicated in this manual. See "Filling the detergent dispenser" and "Filling the rinse aid dispenser"
Water remains in the dishwasher.	The previous cycle has not finished or has been interrupted.	Make sure that the current cycle is finished.
The dishwasher does not drain properly.	The drain is clogged.	Check the air gap (if so equipped). Make sure that the disposer is empty (if so connected).
	The drain hose is kinked.	Make sure that the drain hose is not kinked and is properly connected.
Suds in the tub	Using improper detergent.	Make sure to use only automatic dishwasher detergent.
The dishwasher leaks	Excessive suds caused by using improper detergent.	Make sure to use only automatic dishwasher detergent.
	The dishwasher is not level.	Level the dishwasher (refer to the Installation Manual).
There are black or gray marks on the dishes	Aluminum utensils have rubbed against the dishes.	Use a soft cleaner to remove the stains. Ensure that the water temperature is not less than 120°F.
The interior of the tub is stained	Reddish stain.	Some tomato products may cause this. Use of the rinse only cycle right after loading will help this.
Noises	Detergent cup opening/drain pump.	This is normal.
	A hard object has entered the wash module. When the object is ground up, the noise will stop.	If the noise continues after the cycle is complete, call for service.
The dishwasher won't fill (the dishwasher will beep)	The water valve is turned off.	Turn on the water valve.
	The door may not be closed completely.	Make sure that the door is closed and latched.

Specifications	Details
Capacity	Max 16 place settings
Dimensions (WxDxH)	- unit with decorated door and handle: 23.9 x 26.5 x 33.7 in.
	- unit without decorated door and handle: 23.9 x 24 x 33.7 in.
Power requirements	120 V~60 Hz
Current	8.4 A
Water pressure	Between 20 and 120 psi