

REFRIGERATOR

18.4 cu.ft. Stainless Steel French Door Refrigerator

Model:
KM-RERFDSS-18C

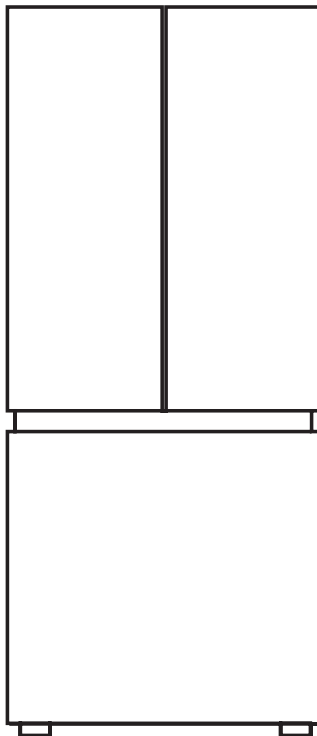

Before using, please read the operating instructions carefully to ensure proper application and achieve satisfactory results.

CONTENTS

SAFETY WARNINGS	2
PRODUCT OVERVIEW	3
PRODUCT INSTALLATION	4
OPERATION INSTRUCTIONS	8
CLEANING AND MAINTENANCE	11
TROUBLESHOOTING	13

SAFETY WARNINGS



Warning: risk of fire / flammable materials

- This appliance is intended to be used in household and similar applications such as staff kitchen areas in shops, offices and other working environments; farm houses and by clients in hotels, motels and other residential type environments; bed and breakfast type environments; catering and similar non-retail applications.
- This appliance is not intended for use by persons (including children) with reduced physical, sensory or mental capabilities, or lack of experience and knowledge, unless they have been given supervision or instruction concerning use of the appliance by a person responsible for their safety.
- Children should be supervised to ensure that they do not play with the appliance. If the supply cord is damaged, it must be replaced by the manufacturer, its service agent or similarly qualified persons in order to avoid a hazard.
- Do not store explosive substances such as aerosol cans with a flammable propellant in this appliance.
- The appliance has to be unplugged after use and before carrying out user maintenance on the appliance.
- WARNING: Keep ventilation openings, in the appliance enclosure or in the built-in structure, clear of obstruction.
- WARNING: Do not use mechanical devices or other means to accelerate the defrosting process, other than those recommended by the manufacturer.
- WARNING: Do not damage the refrigerant circuit.
- WARNING: Do not use electrical appliances inside the food storage compartments of the appliance, unless they are of the type recommended by the manufacturer.
- WARNING: Please abandon the refrigerator according to local regulators for its use flammable blowing gas and refrigerant.
- WARNING: When positioning the appliance, ensure the supply cord is not trapped or damaged.
- WARNING: Do not locate multiple portable socket-outlets or portable power supplies at the rear of the appliance.
- Do not use extension cords or ungrounded (two prong) adapters.
- WARNING: Risk of child entrapment. Before you throw away your old refrigerator or freezer:
 - Take off the doors.
 - Leave the shelves in place so that children may not easily climb inside.
- The refrigerator must be disconnected from the source of electrical supply before attempting the installation of accessory.
- Refrigerant and cyclopentane foaming material used for the appliance are flammable. Therefore, when the appliance is scrapped, it shall be kept away from any fire source and be recovered by a special recovering company with corresponding qualification other than be disposed by combustion, so as to prevent damage to the environment or any other harm.
- The necessity that, for doors or lids fitted with locks and keys, the keys be kept out of the reach of children and not in the vicinity of the refrigerating appliance, in order to prevent children from being locked inside.
- WARNING: To avoid a hazard due to instability of the appliance, it must be fixed in accordance with the instructions.
- WARNING: Connect to potable water supply only. (Suitable for ice making machine)

PRODUCT OVERVIEW

Names of components

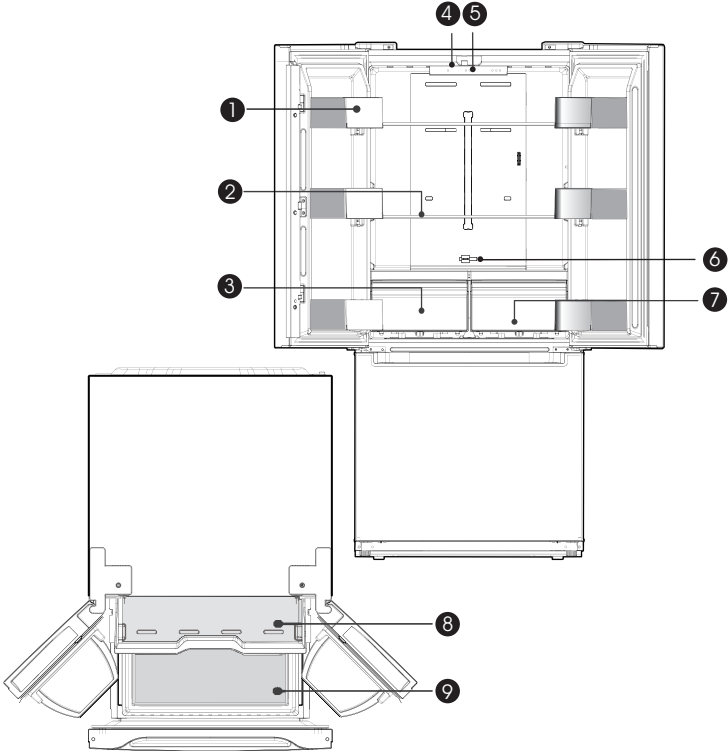

- 1 Door tray
- 2 Shelf
- 3 Fruit and vegetable box
- 4 LED lighting
- 5 Control and display panel
- 6 Quick cold dial block
- 7 Fruit and vegetable box
- 8 Upper freezer drawer
- 9 Lower freezer drawer

ATTENTION

The picture above is only for reference. The actual configuration will depend on the physical product or statement by the distributor

PRODUCT INSTALLATION

Install Instruction

Installing an Optional Ice Maker

The refrigerator comes set up for ice maker installation, This refrigerator is compatible with Midea IM1900MD ice maker. Please refer to individual ice maker installation instruction manual.

- **WARNING:** Connect to potable water supply only.
- Minimum/Maximum inlet water pressure: 138/827 kPa (20/120 psig).

Dimensions and Clearances

- Too small of a distance from adjacent items may result in the degradation of freezing capability and increased electricity costs. Allow over 100 mm of clearance from each adjacent wall when installing the appliance.

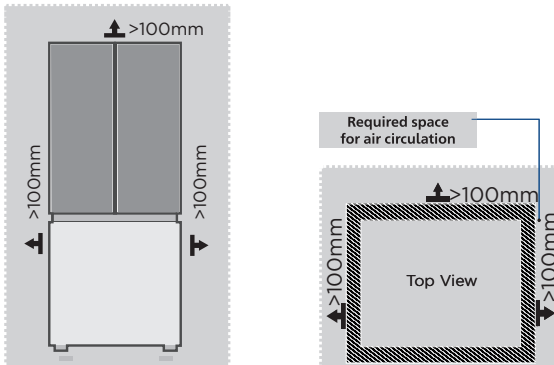

ATTENTION

The picture above is only for reference. The actual configuration will depend on the physical product or statement by the distributor.

Space requirement diagram (when the door is open and when the door is closed)

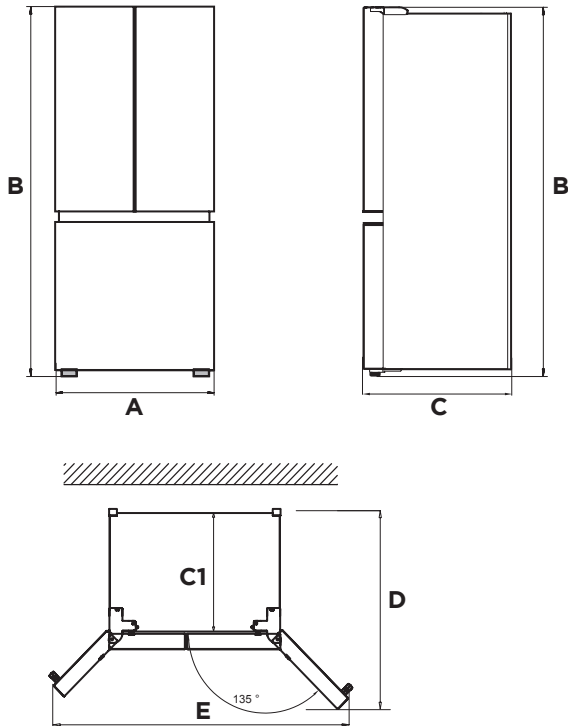

Width	Overall Height	Depth	Depth With handle	Depth doors open 135°	Width doors open 135°
A	B	C	C1	D	E
750	1692	785	705	1038	1277

Notice: All dimensions in mm



Leveling feet

To avoid vibration, the unit must be leveled.

If required, adjust the leveling screws to compensate for the uneven floor.

The front should be slightly higher than the rear to aid in door closing.

Leveling screws can be turned easily by tipping the cabinet slightly.

Turn the leveling screws counterclockwise  to raise the unit, clockwise  to lower it.

Leveling doors

List of tools to be provided by the user



Pliers

Parts included with the kit



Fastener-ring

1. Raise the lower door up to the level of the higher door.
2. Insert the supplied fastener-ring by using plier in the gap between the hinge-grommet and the lower hinge. The number of fastener-rings you will need to insert depends on the gap.

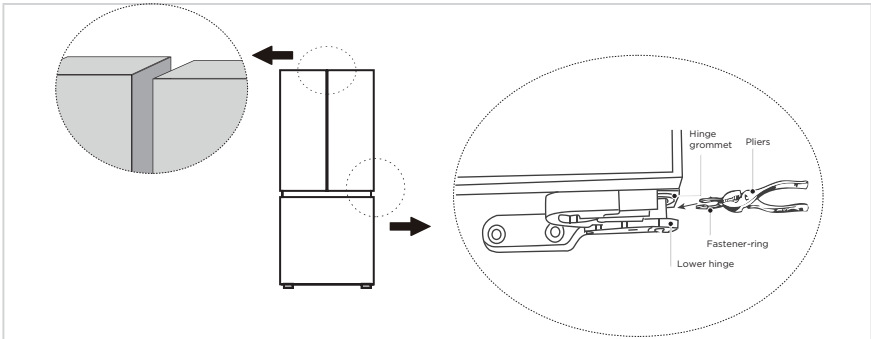

Moving the appliance

1. Remove all food from inside the appliance.
2. Pull the power plug out, insert and fix it into the power plug hook at the rear or on top of the appliance.
3. Tape parts such as shelves and the door handle to prevent from falling off while moving the appliance.
4. Move the appliance with more than two people carefully. When transporting the appliance over a long distance, keep the appliance upright.
5. After installing the appliance, connect the power plug into a socket out to switch on the appliance.

Changing the light

- Any replacement or maintenance of the LED lamps is intended to be made by the manufacturer, its service agent or similar qualified person.

Connecting the appliance

After installing the appliance, connect the power plug into a socket outlet.

ATTENTION

- After connecting the power supply cord (or plug) to the outlet, wait 2 or 3 hours before you put food into the appliance. If you add food before the appliance has cooled completely, your food may spoil.

Precautions before operation:

- Before making changes the refrigerator must be disconnected from power.
- precautions should be taken to prevent any personal injury.

Tips for energy saving

- Do not place the appliance near cookers, radiators or other heat sources. If the ambient temperature is high, the compressor will run more frequently and for longer, resulting in increased energy consumption.
- Ensure that there is sufficient ventilation at the base of the appliance, on the sides of the appliance and at the back of the appliance. Never cover ventilation openings.
- Please also observe the spacing dimensions in the chapter „Installation“.
- The arrangement of drawers, shelves and racks as shown in the illustration offers the most efficient use of energy and should therefore be retained as far as possible. All drawers and shelves should remain in the appliance to keep the temperature stable and save energy.
- To obtain a larger storage space (e.g. for large refrigerated/frozen goods), the middle drawers can be removed. The top and bottom drawers and shelves should be removed last if necessary.
- An evenly filled refrigerator/freezer compartment contributes to optimal energy use. Therefore, avoid empty or half-empty compartments.
- Allow warm food to cool before placing it in the refrigerator/freezer. Food that has already cooled down increases energy efficiency.
- Allow frozen food to defrost in the refrigerator. The coldness of the frozen food reduces the energy consumption in the refrigerator compartment and thus increases the energy efficiency.
- Open the door only as briefly as necessary to minimise cold loss. Opening the door briefly and closing it properly reduces energy consumption.
- The door seals of your appliance must be perfectly intact so that the doors close properly and energy consumption is not increased unnecessarily.

OPERATION INSTRUCTIONS

Control panel

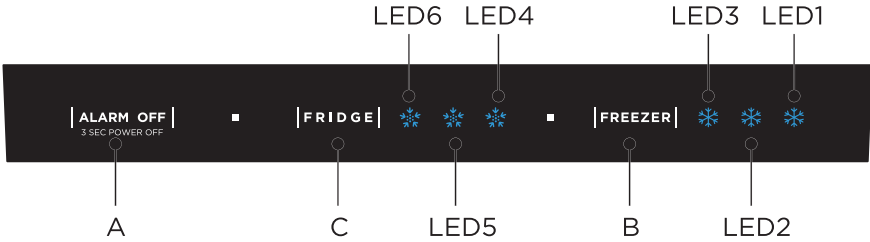

Key

- | | |
|----------|---------------------------------|
| A | Alarm/power off/power on button |
| B | Freezer button |
| C | Fridge button |

Display

When the initial power is up, it is 3 seconds, While the boot bell rings, and then goes into normal operation display. (Refrigerator and freezer are mid-range at the time of first power-up)

Display fault code in the event of a failure (Loop display); display the set gear of the refrigeration room in the event of trouble-free.

Under normal circumstances, the current set gear is displayed, and when a “fault code visible” class failure occurs, the fault code is displayed.

⚠ ATTENTION

The actual control panel may differ from model to model.

Operating instructions

Refrigerator settings

- Press the refrigeration key to adjust the refrigeration set gear, each press the refrigeration key once, the gear change one gear, the order is as follows:

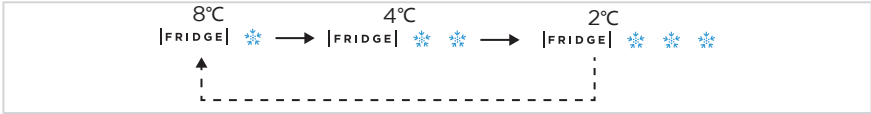

Freezer settings

- Press the refrigeration key to adjust the refrigeration set gear, each press the refrigeration key once, the gear change one gear, the order is as follows:



Note: The temperature of each gear is within 32 of the set temperature, and the actual situation is slightly different according to the load situation.

Alarm off

- When a fault alarm occurs, press the alarm off key short, and the fault alarm sound is canceled.

Open the door and alarm

- When the freezer door or refrigerator door opens for 120 seconds without shutting down or not closed well, the buzzer alarms until the freezer door or refrigerator door closes. Or press the alarm off key to cancel the buzzer alarm.

Standby mode

- Press the alarm off key for 3 seconds to enter standby mode, cooling stops, light not on, display is off. In standby mode, long press the alarm off for 3 seconds, return to normal control.

Fault indication

- The following warnings appearing on the display indicate corresponding faults of the refrigerator. Though the refrigerator may still have refrigerator a freezing function with the following faults, the user shall contact maintenance specialist for maintenance, so as to ensure normal use of the refrigerator.

Fault Code	Fault Description
LED1/LED2 flashing	Refrigerator temperature sensor fault
LED1/LED5 flashing	Freezer temperature sensor fault
LED1/LED3 flashing	Freezing frost sensor faults
LED2/LED4flashing	Communication failure
LED1/LED4 flashing	Ambient temperature sensor faults
LED2/LED5 flashing	Humidity sensor error

Tips on storing food

Freezer compartment

- The freezer is designated for the storage of food frozen at very low temperature, long-term storage of frozen food, and for the production of ice.
- Only use the shelves in the door of the freezer to store frozen food, not for storing hot food designated for freezing.
- Do not put fresh and frozen food next to each other. The frozen food may thaw.
- When freezing fresh food (such as meat, fish or chopped meat), cut them into parts that can be used at the same time.
- Storing frozen food: instructions are usually stated on the packages, which must be followed. If there is no information on the packaging, food should not be stored for longer than three months from the date of purchase.
- When purchasing frozen food, make sure that it was frozen at a suitable temperature and that the packaging is not damaged.
- Frozen food should be kept in suitable packages to retain the quality and should be returned to the freezer compartment as soon as possible.
- If a package of frozen food shows moisture or abnormal bulging, it is probable that it was stored at the wrong temperature and the content is spoiled.
- The storage period for frozen food depends on the room temperature, the thermostat setting, the frequency of opening the door of the freezer, the type of food and the time of transporting the product from the shop to the household. Always follow the instructions printed on the packaging and never exceed the maximum storage time stated on the package.

Cooling compartment

- To reduce moisture and subsequent ice build-up, never put liquid into the refrigerator in unsealed containers. Frost tends to concentrate in the coolest parts of the evaporator. Storing uncovered liquids results in a more frequent need for defrosting.
- Never put warm foods in the refrigerator. These should first cool down at room temperature and then be placed so as to ensure adequate air circulation in the refrigerator.
- Foods or food containers should not touch the back wall of the refrigerator because they could freeze to the wall. Do not keep regularly opening the door of the refrigerator.
- Meat and clean fish (packed in a package or plastic foil) can be placed in the refrigerator, which can be used in 1-2 days.
- Fruit and vegetables without packaging can be placed in the part designated for fresh fruit and vegetables.

Recommended Temperature

The optimal temperature setting for food storage:

- Fridge: 4 °C , Freezer: -19°C

ATTENTION

The optimal temperature setting of each compartment depends on the ambient temperature. Above optimal temperature is based on the ambient temperature of 25 °C.

CLEANING AND MAINTENANCE

Defrosting

- The refrigerator is made based on the air-cooling principle and thus has automatic defrosting function. Frost formed due to change of season or temperature may also be manually removed by disconnection of the appliance from power supply or by wiping with a dry towel.

Cleaning of door tray

- According to the direction arrow in the figure below, use both hands to squeeze the tray, and push it upward, then you can take it out.
- After washing the tray having been taken out, you can adjust its installing height in accordance with your requirement.

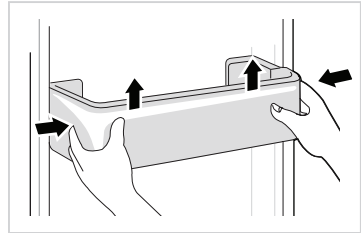

Cleaning of glass shelf

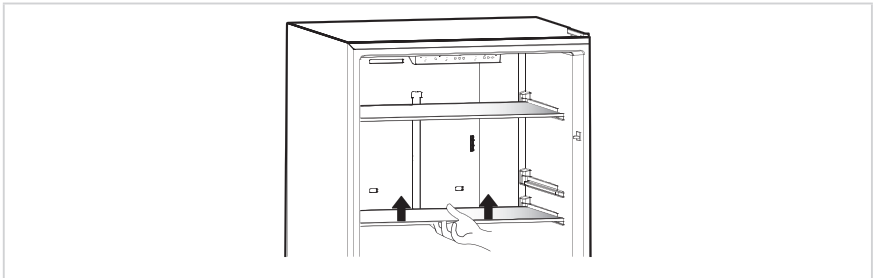

Please dismantle the cantilever shelf according to the arrows shown as above :

1. Since the shelf and the box gall have the innermost stop, first lift the shelf up, and then pull out outward.

Cleaning of Box gall bottom roller groove

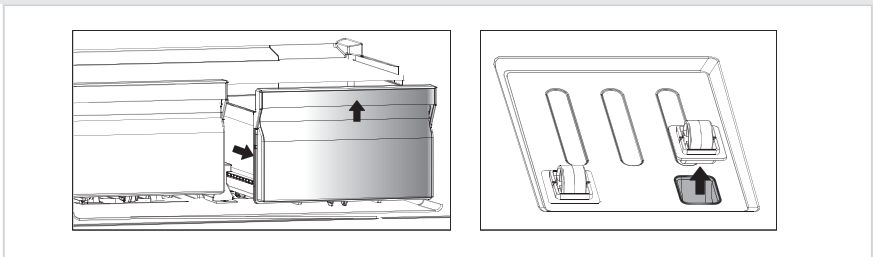

- First pull out the fruit and vegetable box, because the fruit and vegetable box has a stop, it needs to be lifted upward before the fruit and vegetable box can be removed.
- The roller seat is stuck in the box tank groove, press the arrow in the direction of the image, remove the roller seat, clean the box tank groove as needed.

Cleaning of freezer lower drawer

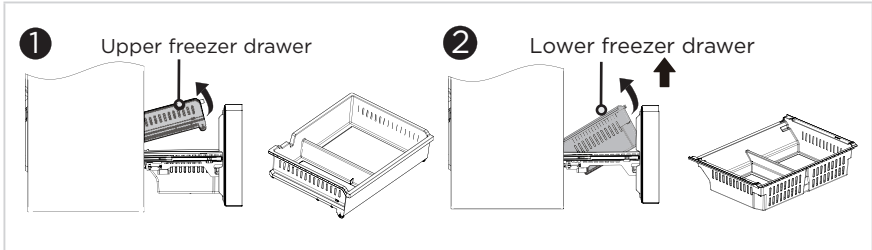

Upper freezer drawer:

- Open the freezing chamber door to the maximum stroke, lift the tail of the upper drawer of the freezing chamber, take out the upper freezer drawer.

Lower freezer drawer:

- Open the freezing chamber door to the maximum stroke, Lift the end of the lower freezer drawer and lift it up.

● ATTENTION

Note: Don't remove the lower freezer drawer if not necessary.

Stop using

Power failure:

In case of power failure, even if it is in summer, foods inside the appliance can be kept for several hours; during the power failure, the times of door opening shall be reduced, and no more fresh food shall be put into the appliance.

Long-time nonuse:

The appliance shall be unplugged and then cleaned; then the doors are left open to prevent odor.

Moving:

Before the refrigerator is moved, take all objects inside out, fix the glass partitions, vegetable holder, freezing chamber drawers and etc. with tape, and tighten the leveling feet; close the doors and seal them with tape. During moving, the appliance shall not be laid upside down or horizontally, or be vibrated; the inclination during movement shall be no more than 45°.

● ATTENTION

The appliance shall run continuously once it is started. Generally, the operation of the appliance shall not be interrupted; otherwise the service life may be impaired. Foods can be preserved for a couple of hours even in summer in case of power failure; it is recommended to reduce the frequency of opening door.

TROUBLESHOOTING

The following simple issues can be handled by the user. Please call the after-sale service department if the issues are not solved.

Problem	Possible reason
Failed operation	<ul style="list-style-type: none"> • Check whether the appliance is connected to power or whether the plug is in well contact
	<ul style="list-style-type: none"> • Check whether the voltage is too low
	<ul style="list-style-type: none"> • Check whether there is a power failure or partial circuits have tripped
Odor	<ul style="list-style-type: none"> • Odorous foods shall be tightly wrapped
	<ul style="list-style-type: none"> • Check whether there is any rotten food
	<ul style="list-style-type: none"> • Clean the inside of the refrigerator
Long-time operation of the compressor	<ul style="list-style-type: none"> • Long operation of the refrigerator is normal in summer
	<ul style="list-style-type: none"> • when the ambient temperature is high It is not suggestible having too much food in the appliance at the same time
	<ul style="list-style-type: none"> • Food shall get cool before being put into the appliance
	<ul style="list-style-type: none"> • The doors are opened too frequently
Light fails to get lit	<ul style="list-style-type: none"> • Check whether the refrigerator is connected to power supply and whether the illuminating light is damaged
	<ul style="list-style-type: none"> • Have the light replaced by a specialist
Door can not be properly closed	<ul style="list-style-type: none"> • The door is stuck by food packages Too much food is placed
	<ul style="list-style-type: none"> • The refrigerator is tiltedr.
Loud noises	<ul style="list-style-type: none"> • Check whether the floor is level and whether the refrigerator is placed stably
	<ul style="list-style-type: none"> • Check whether accessories are placed at proper locations

Problem	Possible reason
Door seal fails to be tight	<ul style="list-style-type: none"> • Remove foreign matters on the door seal
	<ul style="list-style-type: none"> • Heat the door seal and then cool it for restoration (or blow it with an electrical drier or use a hot towel for heating)
Water pan overflows	<ul style="list-style-type: none"> • There is too much food in the chamber or food stored contains too much water,resulting in heavy defrosting
	<ul style="list-style-type: none"> • The doors are not closed properly, resulting in frosting due to entry of air and increased water due to defrosting
Hot housing	<ul style="list-style-type: none"> • Heat dissipation of the built-in condenser via the housing, which is normal When housing becomes hot due to high ambient temperature, storage of too much food or shutdown of the compressor is shut down, provide sound ventilation to facilitate heat dissipation
Surface condensation	<ul style="list-style-type: none"> • Condensation on the exterior surface and door seals of the refrigerator is normal when the ambient humidity is too high. Just wipe the condensate with a clean towel.
Abnormal noise	<ul style="list-style-type: none"> • Buzz: The compressor may produce buzzes during operation, and the buzzes are loud particularly upon start or stop. This is normal.
	<ul style="list-style-type: none"> • Creak: Refrigerant flowing inside of the appliance may produce creak, which is normal.