



Mont Alpi®

Peak Performance





Mont Alpi®

Peak Performance





THE MONT ALPI STORY

At Mont Alpi, we are committed to empowering outdoor cooks of all levels to achieve their culinary goals. Driven by a passion for outdoor cooking, we design and craft innovative, high quality grills that make it easy to create delicious meals that impress friends and family.

As a family-run business with over 45 years of experience in the grilling industry, we understand the importance of crafting durable and expertly designed grills to ensure peak performance. That's why we created a range of modular, 'plug-and-play' outdoor kitchen islands and grills that deliver outstanding cooking experiences.

With our expanded range of products, you can find the perfect configuration to fit your outdoor setting.

We're more than just a grill manufacturer; we're a community of enthusiasts dedicated to supporting and guiding our customers every step of the way. Whether you have a question about one of our products or need some grilling advice, we are always here to help.

With Mont Alpi Grills, effortless outdoor cooking and masterful meals are just a grill away. Making you the peak performing outdoor chef of your neighborhood.

CONTENTS

MONT ALPI DELUXE SERIES

- p4 MAi805-D Series 6-burner deluxe grills
- p6 MAi400-D Series 4-burner deluxe grills

MONT ALPI ORIGINAL SERIES

- p8 MAi805 Series 6-burner original grills

MONT ALPI BLACK STAINLESS-STEEL

- P10 MAi805-BSS Series 6-burner black stainless-steel grills

MONT ALPI COMPACT ISLANDS

- P12 Black, and stainless steel MA-957 islands

MONT ALPI BUILT-IN GRILLS

- p14 MABi805 / MABi805-BSS 6-burner built-in grills
- MABi400 / MABi400-BSS 4-burner built-in grills

MONT ALPI ART-WOOD ISLANDS

- p16 MA805-AW / MA805-AWBSS 6-burner islands
- MA400-AW / MA400-AWBSS 4-burner Islands

MONT ALPI SPECIALTY MODULES

- p18 Mont Alpi Speciality modules
- p20 Mobile Outdoor Prep Centers / Bar Carts
- p22 Mont Alpi Beverage Centers
- p24 Mont Alpi Refrigerator Modules

- p25 Mont Alpi Pizza Oven
- p25 Mont Alpi Corner Modules

MONT ALPI ACCESSORIES

- p26 Grill Covers
- P27 Other Accessories

CUSTOMER SUPPORT

- p28 Support & Warranties



Experience the Peak Performance and Epitome of Deluxe Outdoor Grilling with the **MontAlpi® MAi805-D SERIES**



MAi805-D90FC pictured

MAi805-D 6-BURNER SPECIFICATIONS

- 115,000 BTU Heat Output
- Cooking surface 38"x18" (exc. Warming rack)
- All 304 Stainless Steel components:
 - Six 304 Stainless Steel Burners
 - 8mm 304 Stainless Steel Cooking Grills
 - Warming Rack 304 Stainless Steel
- Ceramic infrared rear and side burners
- Rotisserie Kit with Electric Motor
- Easy access Full Front Grease Tray
- Composite Granite Surfaces and Sides (White)
- Two Cooking Surface Halogen Lights
- Bottle Opener
- Weather Cover
- Electronic Ignition
- Temperature Gauge
- Granite Chopping Board
- On/Off red/blue changing color control knob lights
- Large Roller Ball Drawers
- Gliding Rubber Castor Wheels and Leveling Feet
- Propane Ready, easily Convertible to Natural Gas
- - Propane Hose and Regulator
- - Propane Tank Pull Out



Modules arrive fully assembled

MAi805-D SERIES 6-BURNER SETUP OPTIONS



MAi805-D



MAi805-D45

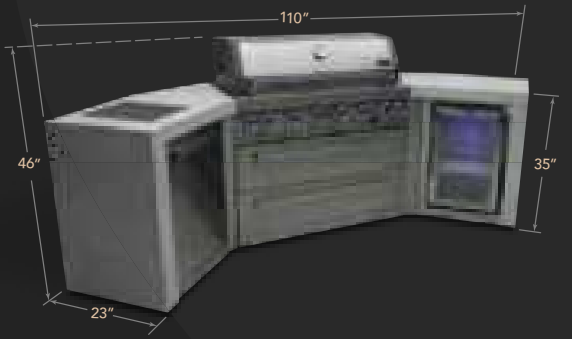

MAi805-D45FC



MAi805-D90



MAi805-D90BEV



MAi805-D90BEVFC



MAi805-DBEV



MAi805-DBEVFC

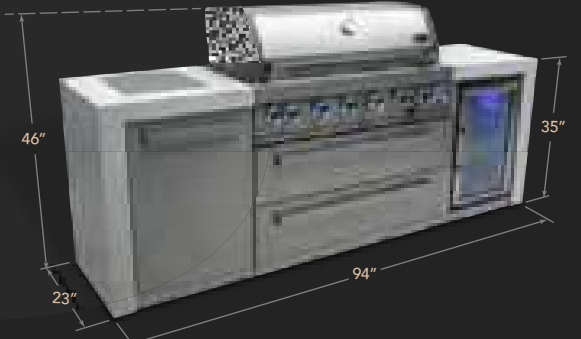

MAi805-DFC

Experience all the power you need
to cook your meals to perfection with the
MontAlpi® MAi400-D SERIES



MAi400-DFC pictured

MAi400-D 4-BURNER SPECIFICATIONS

- 78,000 BTU Heat Output
- Cooking surface 28"x18" (exc. Warming rack)
- All 304 Stainless Steel components-
 - Four 304 Stainless Steel Burners
 - 8mm 304 Stainless Steel Cooking Grills
 - Warming Rack 304 Stainless Steel
- Ceramic infrared rear and side burners
- Two Cooking Surface Halogen Lights
- Rotisserie Kit with Electric Motor
- Composite Granite Surfaces and Sides (White)
- Bottle Opener

- Weather Cover
- Temperature Gauge
- Electronic Ignition
- Granite Chopping Board
- Large Roller Ball Drawers
- On/Off red/blue changing color control knob lights
- Gliding Rubber Castor Wheels and Leveling Feet
- Propane Ready, easily Convertible to Natural Gas
- - Propane Hose and Regulator
- - Propane Tank Pull Out

Modules arrive fully assembled



MAi400-D SERIES 4-BURNER SETUP OPTIONS

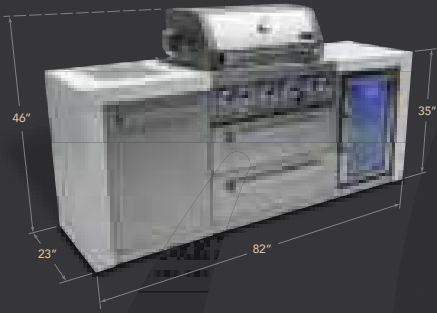

MAi400-DFC

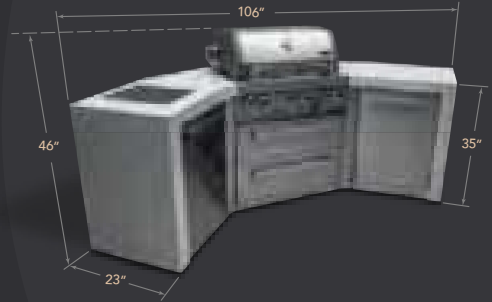

MAi400-D45



MAi400-D45FC

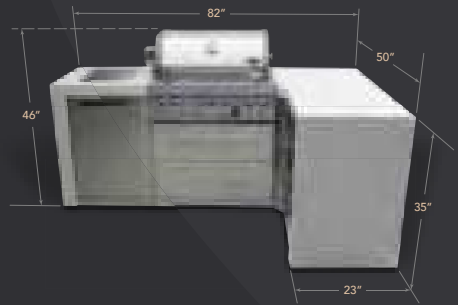

MAi400-D90C

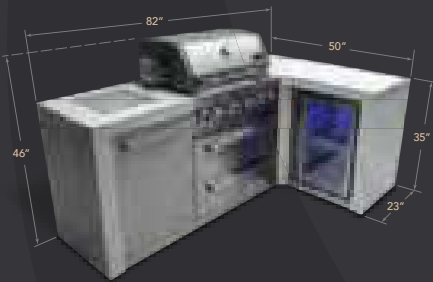

MAi400-D90FC



MAi400-D90BEV

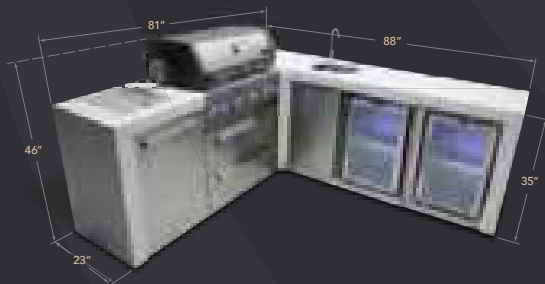

MAi400-D90BEVFC

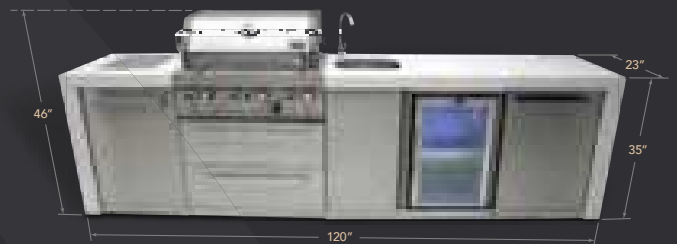

MAi400-DBEV

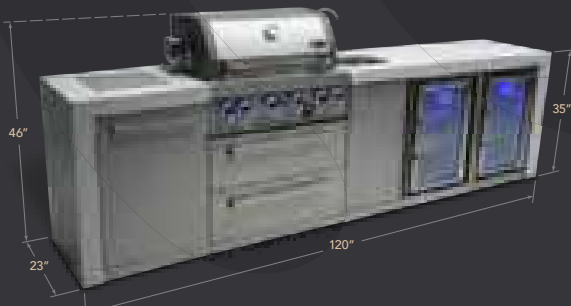

MAi400-DBEVFC



MAi400-D90KEGFC

Experience the quality and longevity of our original line of grills - where it all began

Mont Alpi[®] MAi805 SERIES



MAi805 pictured



MAi805 6-BURNER SPECIFICATIONS

- 115,000 BTU Heat Output
 - Cooking surface 38"x18" (exc. Warming rack)
 - All 304 Stainless Steel components:
 - Six 304 Stainless Steel Burners
 - 8mm 304 Stainless Steel Cooking Grills
 - Warming Rack 304 Stainless Steel
 - Electronic Ignition
 - Ceramic infrared rear and side burners
 - Easy access Full Front Grease Tray
 - Composite Granite Surfaces and Sides (White)
 - Two Cooking Surface Halogen Lights
 - Bottle Opener
 - Temperature Gauge
 - Granite Chopping Board
 - Large Roller Ball Drawers
 - On/Off red/blue changing color control knob lights
 - Gliding Rubber Castor Wheels and Leveling Feet
 - Propane Ready, easily Convertible to Natural Gas
 - - Propane Hose and Regulator
 - - Propane Tank Pull Out
- Option to add Weather Cover*
- Option to add a Rotisserie Kit / Electric Motor*
- Modules arrive fully assembled**

MAi805 SERIES 6-BURNER SETUP OPTIONS

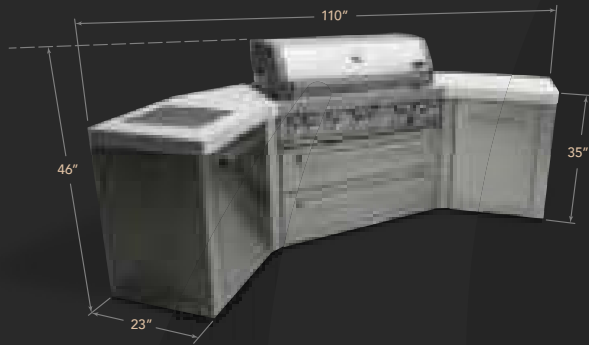

MAi805-45C

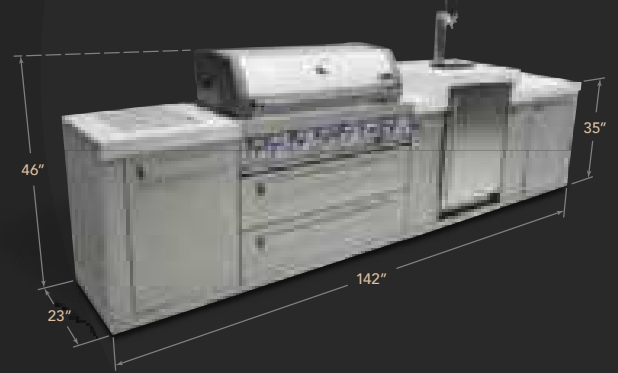

MAi805-KEG

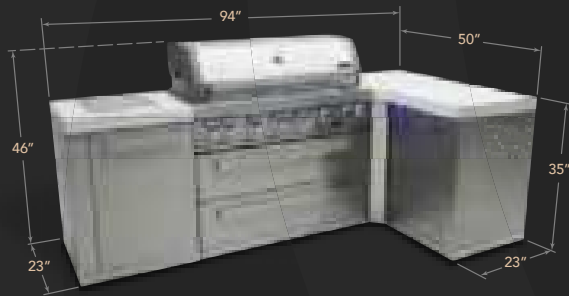

MAi805-90C



MAi805-90KEG

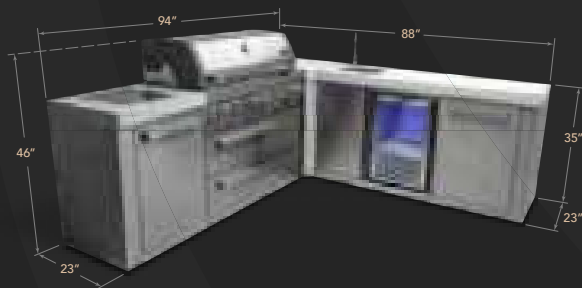

MAi805-90BEV



MAi805-KEGBEV



MAi805-BEV

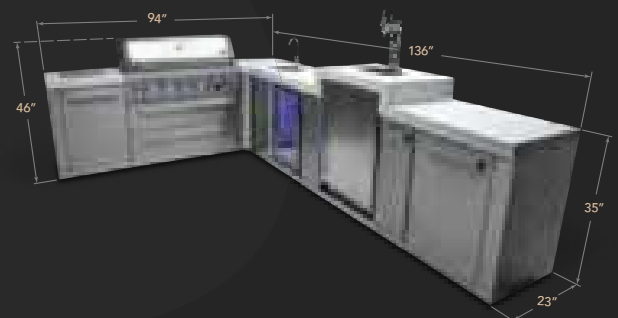

MAi805-90KEGBEV

The perfect combination of performance and luxury for those seeking a little extra opulence

MontAlpi® MAi805-BSS SERIES



MAi805-BSSBEV pictured



MAI805-BSS SERIES SPECIFICATIONS:

- 115,000 BTU Heat Output
 - Cooking surface 38"x18" (exc. Warming rack)
 - All 304 Stainless Steel components
 - Six 304 stainless steel burners
 - 8mm 304 stainless steel cooking grills
 - Warming rack 304 stainless steel
 - Electronic Ignition
 - Ceramic infrared rear and side burners
 - Rotisserie kit with electric motor
 - Temperature Gauge
 - Easy access Full Front Grease Tray
 - Composite Granite Surfaces (White)
 - Bottle Opener
 - Weather Cover
 - Two Cooking Surface Halogen Lights
 - On/Off red/blue changing color control knob lights
 - Large Roller Ball Drawers
 - Gliding Rubber Castor Wheels and Leveling Feet
 - Propane Ready, easily Convertible to Natural Gas
 - - Propane Hose and Regulator
 - - Propane Tank Pull Out
- Modules arrive fully assembled

MAI805-BSS SERIES 6-BURNER SETUP OPTIONS

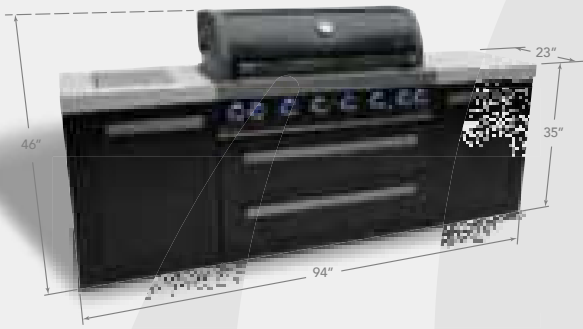

MAi805-BSS



MAi805-BSSFC

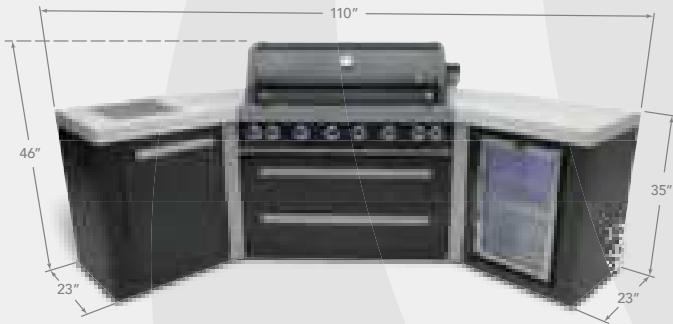

MAi805-BSS45FC

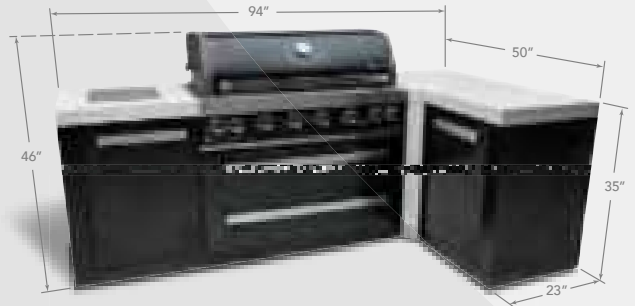

MAi805-BSS90C



MAi805-BSS45C

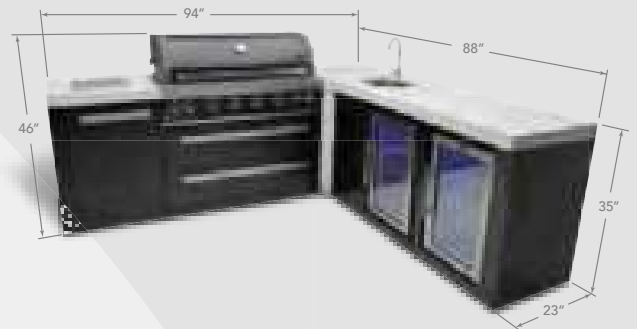

MAi805-BSS90BEVFC



MAi805-BSS90BEV

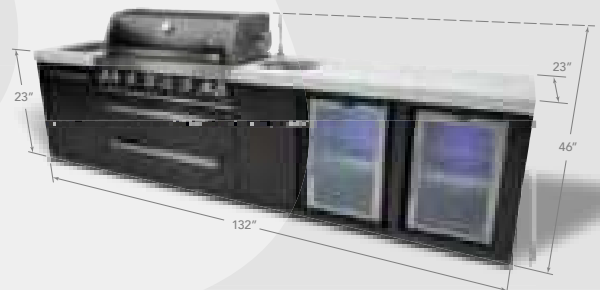

MAi805-BSSBEVFC

The perfect combination of versatility and style
MontAlpi COMPACT ISLANDS



MA-957FC pictured



MA-957FCRS pictured

SETUP OPTIONS

Introducing the Mont Alpi Compact Island series, four high-performing compact islands available in either stainless steel, or black stainless steel construction. Full of style and packed with features, with or without a stunning outdoor refrigerator.

Our 957 series compact islands are the perfect option for those that want an all-inclusive grilling experience. The modules come pre-assembled for hassle-free setup, and include a full-size cover and heavy duty rotisserie kit. Plus, with gliding rubber castor wheels and leveling feet, it's easy to move or stabilize your island for ultimate outdoor cooking convenience.

COMPACT ISLANDS SPECIFICATIONS:

- 63,000 BTU Heat Output
- Cooking surface 28"x18" (exc. Warming rack)
- **304 Stainless Steel** components:
 - **Four** 304 stainless steel burners
 - 8mm 304 stainless steel cooking grills
 - Warming rack 304 stainless steel
- Electronic Ignition
- Ceramic infrared rear burner
- Rotisserie kit with electric motor
- Bottle Opener
- Temperature Gauge
- Full Weather Cover
- Two Cooking Surface Halogen Lights
- On/Off red/blue changing color control knob lights
- Gliding Rubber Castor Wheels and Leveling Feet
- Propane Ready, easily Convertible to Natural Gas
- - Propane Hose and Regulator

Modules arrive fully assembled

MA-957FC & MA-957FCRS Refrigerator

- **Capacity:** 38 liters
- **Dimensions:** 15.5" x 20.5" x 20"



MA-957FC



MA-957FCRS



MA-957



MA-957RS





MABi805 and MAF(fridge module) pictured

Make your backyard the heart of your home

Mont Alpi® BUILT-IN GRILLS

MONT ALPI BUILT-IN GRILLS ARE THE PERFECT ADDITION TO ANY AMERICAN BACKYARD KITCHEN BUILD!

Mont Alpi Built-in Grills are built to provide ample space for you to cook for your loved ones and bring your family together for delicious meals and memories. Both the four and a six burner built-in models come with ceramic infrared rear burners,

and all 304 stainless steel components. Each grill is ready to use straight out of the box. They also include a rotisserie kit with electric motor, bottle opener, weather cover, two cooking surface halogen lights, on/off red/blue color changing control knob lights, and electronic ignition, making it easy to create a delicious meal for your family. Bring your family together with a Mont Alpi Built-in Grill and make your backyard the heart of your home.

BUILT-IN OPTIONS

MABi805 / MABi805-BSS - BUILT IN 44" GRILLS

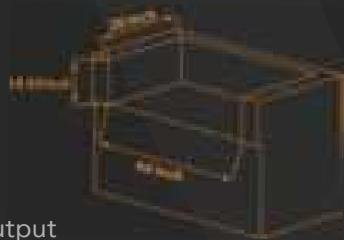
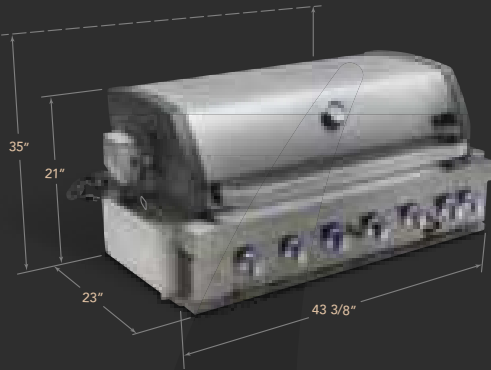

- 87,000 BTU Heat Output
- Cooking surface 38"x18" (exc. Warming rack)
- Six 304 stainless steel burners

MABi400 / MABi400-BSS - BUILT IN 32" GRILLS

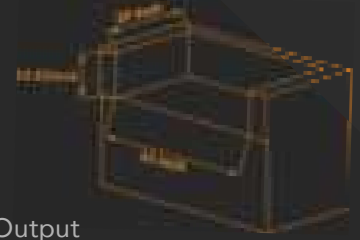
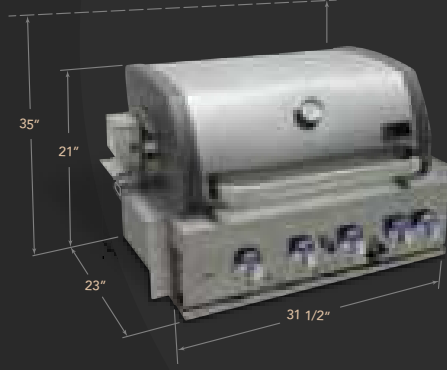

- 63,000 BTU Heat Output
- Cooking surface 28"x18" (exc. Warming rack)
- Four 304 stainless steel burners

COMMON FEATURES:

- All 304 stainless steel components
 - 304 stainless steel burners
 - 8mm 304 stainless steel cooking grills
 - Warming rack 304 stainless steel
- Ceramic Infrared Rear Burner
- Rotisserie Kit with Electric Motor
- Temperature Gauge
- Two Cooking Surface Halogen Lights
- On/Off red/blue changing control knob lights
- Electronic Ignition
- Bottle Opener
- Weather Cover
- Propane Ready
- - Propane Hose and Regulator
- - Easily Convertible to Natural Gas
- Easy access Full Front Grease Tray

Delivered fully assembled



MA805-AW pictured

Bring your family together around **Mont Alpi** ART-WOOD ISLANDS

INTRODUCING THE MONT ALPI ART-WOOD SERIES - A MASTERPIECE OF CRAFTSMANSHIP.

Our Island cabinetry, crafted from recycled materials, promises durability with UV protection and rust resistance. Delivered fully assembled on wheels, it's a breeze to set up. The harmonious blend of art-wood and marine-grade stainless steel

radiates timeless elegance, suited for both modern and traditional patios. With an oversized white granite countertop, maintenance is a breeze.

Stylish and hassle-free, this stand-alone solution fits most spaces. Available in 4 and 6 burners, the Mont Alpi Art-Wood Series is your key to effortless outdoor cooking sophistication.

MONT ALPI ART-WOOD ISLANDS SETUP OPTIONS



MA805-AW



MA805-AWBSS



MA400-AW



MA400-AWBSS

All Mont Alpi Artwood Islands are delivered fully assembled

More Storage. More Versatility

Expand Your Outdoor Kitchen with a

Mont Alpi® SPECIALTY MODULE

With Mont Alpi Specialty Modules, your outdoor kitchen isn't just a place to cook—it's an experience. Designed to enhance both function and style. Expand prep space, increase storage, or introduce new cooking capabilities with seamless add-ons that enhance your setup.

The **Extra Cabinet Module** provides sleek stainless-steel storage, while the **Kamado Module**

brings the art of slow-smoked perfection to your grilling lineup. For the ultimate entertainer, the **Keg Module** keeps the good times flowing, featuring an outdoor-rated fridge that holds up to three 1/6th barrels with three taps.

Each module blends effortlessly into your island, offering premium finishes, durable materials, and thoughtful design.

MA-EXC (EXTRA CABINET MODULE)

Available in **Stainless Steel (SS)** & **Black Stainless Steel (BSS)**

A versatile storage solution designed to seamlessly integrate with Mont Alpi outdoor kitchens, providing extra space while maintaining a sleek, high-quality finish.

KEY FEATURES:

- Compatible with all Mont Alpi outdoor kitchen islands
- Additional storage space for tools, accessories, or ingredients
- Includes two-tier removable shelving for flexible storage
- Right-hinged door for convenient access
- Leveling legs included for stability on uneven surfaces
- W 25" D 23" H 35"
- Ships pre-assembled



MA-EXC



MA-EXCBSS



MA-805 +MA-EXC pictured

MA-KAM (KAMADO MODULE)

Expand your grilling options with the Kamado Module, designed for slow-smoked cooking perfection. This module allows Mont Alpi outdoor kitchen users to seamlessly integrate a Kamado-style charcoal grill into their setup.

KEY FEATURES:

- Premium stainless-steel construction for durability and style
- Provides stable, heat-resistant housing for Kamado grills
- Seamless modular integration into existing Mont Alpi setups
- W 23" L 33" H (excluding Kamado grill): 35"
- Designed to fit Kamado grills with an 18.5" cooking diameter or smaller
- Compatible with all Mont Alpi models except the 957 series

**Kamado grill sold separately*



MA-KAM

MA-KEG (KEG MODULE / KEG CENTER)

Turn your outdoor kitchen into the ultimate entertainment hub with the Mont Alpi Keg Module. This module brings a fully integrated draft system to your grilling space.

KEY FEATURES:

- Outdoor-rated fridge maintains optimal serving temperatures
- Holds up to three 1/6th barrels (three one-sixth barrels)
- Includes three taps for multiple beverage options
- White granite countertop for a sleek and durable finish
- Works as a modular unit with any stainless-steel Mont Alpi island or as a standalone unit



MA-805BEVKEG pictured





MAPCL pictured

Mont Alpi®

MOBILE OUTDOOR PREP CENTERS / BAR CARTS

The perfect entertaining addition to any patio.

A STYLISH AND WELL THOUGHT OUT PREP CART AND REFRIGERATOR IS THE PERFECT ADDITION TO ANY PATIO.

An outdoor rated refrigerator for ice cold beverages and a beautiful porcelain countertop for chopping, serving and prepping, topped off with high quality stainless steel and hammer-tone materials designed

to withstand the elements and provide a stylish aesthetic. Great on the Patio to accompany your gas or charcoal grill and an excellent place to stand your tabletop griddle, grill or pizza oven.

A entertainers dream machine, the ultimate bar cart, prep station and serving station rolled into one super stylish package.

MOBILE OUTDOOR PREP CENTERS / BAR CARTS SETUP OPTIONS



All bar carts are delivered fully assembled

Mont Alpi® BEVERAGE CENTERS

Mont Alpi Beverage Centers make a beautiful addition to any Mont Alpi grill island or as a stand alone beverage center on your patio. Each unit is available in regular stainless steel or black stainless steel.

MASF



Entertain like never before and let the good times roll

All our Mont Alpi Beverage Centers come with an outdoor rated refrigerator with lights, lockable door, and a stainless steel sink with faucet. Each unit is made with all 304 marine grade stainless steel and is finished with white granite counter top.

MASF-BSS

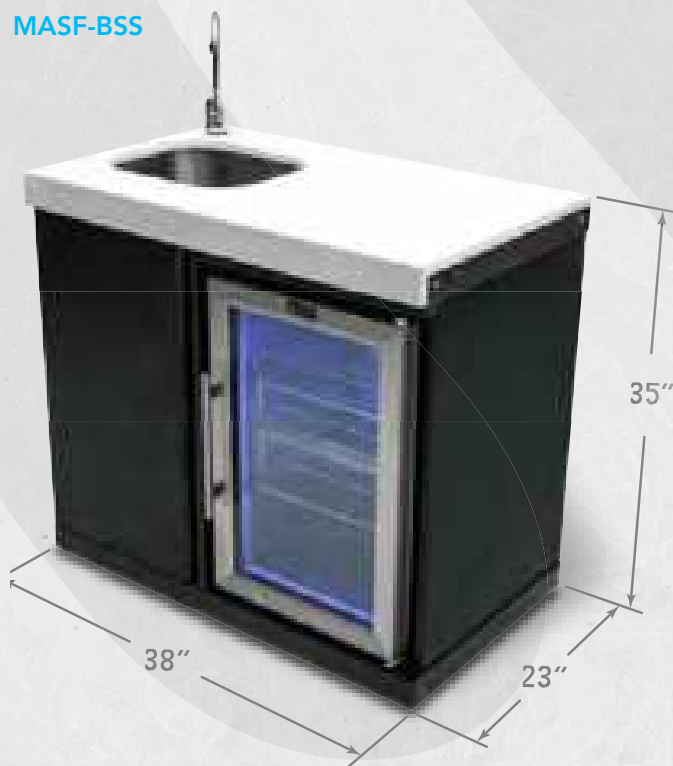

MA-BEVBS90FC

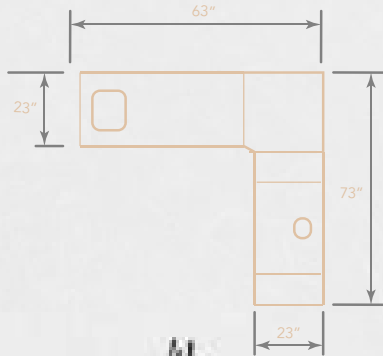

MA-BEVBS9FC



MA-BEVKEG

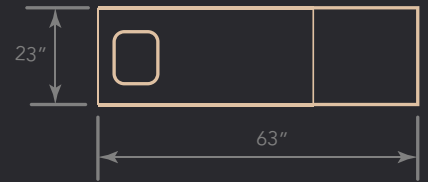

MA-BEV90KEG

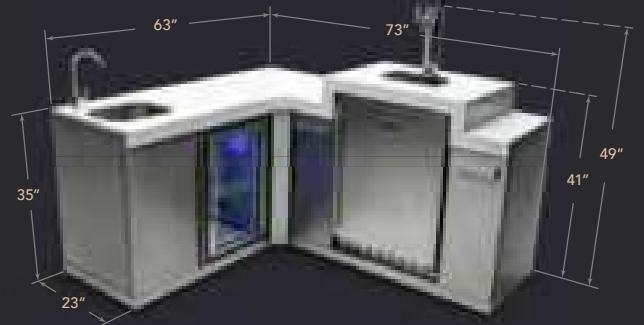
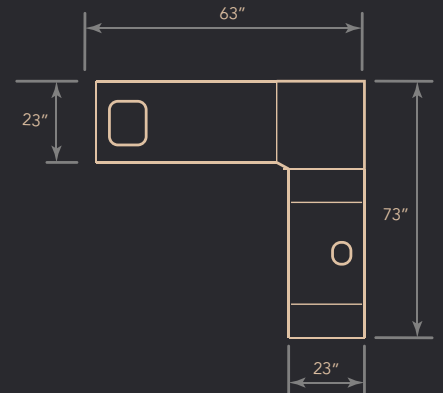

Mont Alpi®

REFRIGERATION MODULES

All **Mont Alpi refrigerators** are outdoor rated, lockable, temperature adjustable and have a stylish blue LED light. The 3 options allow you to add this module to any stainless steel deluxe island, black stainless steel island or a stand alone unit.

MASFM-BSS



MASFM



MAF



Let the pizza party begin!

Mont Alpi® PIZZA OVEN

- Stainless Steel
- "U" Shaped Burner for all around high heat
- 12,000 BTU
- Oven like performance in 5 minutes (620 F)
- 12" Pizza Stone
- Removable Floor Pan
- Pull out fat tray
- Dishwasher friendly cleaning
- Net weight 27 lbs
- Easy Start up Ignition
- Great for roasting (whole chickens and larger meats)
- Removable Front Door
- Accurate Temperature Gauge
- Propane (convertible to natural gas)



MAPZ-SS

Mont Alpi®

45° AND 90° CORNER MODULES

CORNER MODULES

Elevate your outdoor kitchen and create the ideal corner configuration for your space with Mont Alpi's Corner Modules. Choose 45 or 90 degrees for a sleek and functional design.

Crafted from durable stainless steel, ensuring longevity and rust resistance.



MA45C



MA90C



Mont Alpi® GRILL COVERS

Protect your investment and keep your grill looking like new.

All **Mont Alpi covers** are designed with maximum durability in mind in order to protect the stainless steel finish in across all weather conditions and keep your grill looking it's best. Zipper closures allow any grill and module combination to be covered perfectly. Each module cover will zip to another in any combination. These are some of our most popular options.



COVBi805, COVBi400



COVMAi805, COVMAi400



COVMASF



COVMAi805-BEV, COVMAi805-DBEV, COVMAi805-BSSBEV



POCB Pizza oven carry bag

Mont Alpi®

ACCESSORY LINES

ACCESSORIES



Universal side burner pizza oven

MASBP



3pc tool kit

MATK



Pizza kit

MAPK



Dual sided griddle plate

MAGR



Solid hot plate kit

MASHP



Rotisserie kit

MAROTIS



Natural gas conversion kit

MANGK

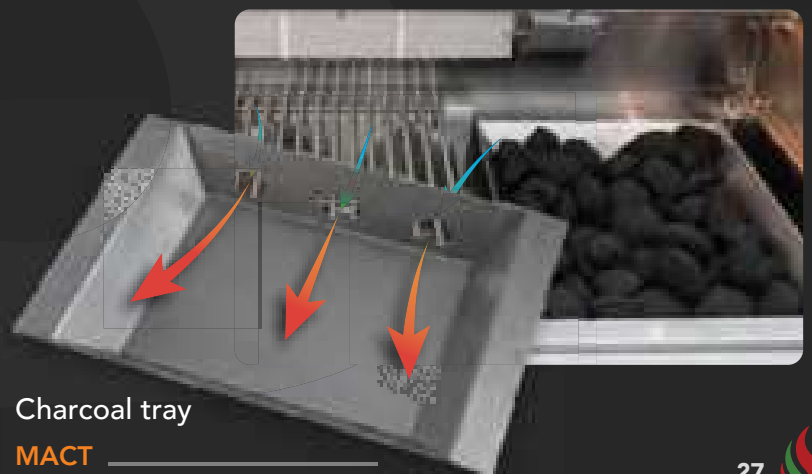

Charcoal tray

MACT



Mont Alpi® CUSTOMERS

Trust Mont Alpi for a top-notch grilling experience

PRODUCT SUPPORT

At Mont Alpi, we pride ourselves on providing exceptional customer service and support. Our grills are not just a purchase, they're an investment in your outdoor cooking experience. That's why we offer comprehensive product support and warranties to ensure your satisfaction with your Mont Alpi grill.

Our dedicated product support team is available to assist with any questions or concerns you may have about your grill, from assembly to operation and maintenance.

We also provide detailed owner's manuals and instructional videos for added guidance.

LIMITED LIFETIME WARRANTY

If you ever encounter an issue with your Mont Alpi grill, our team will work with you to resolve it and ensure your complete satisfaction.

Our standard warranty covers all defects in materials and workmanship, including coverage for all parts.

Mont Alpi is committed to providing our customers with the best possible service and support, so you can enjoy your grill for years to come.



ADDRESS: 15271 Barranca PKWY Irvine CA 92618

CALL: +1 949-207-9595

EMAIL: info@MontAlpiOnline.com

www.MontAlpiOnline.com