



UNIVERSAL APPLIANCE JACKET

**PRODUCT**  
33" APPLIANCE JACKET  
  
**Item No.** SUNJK33

**DESCRIPTION**  
33" JACKET FOR GRILLS WITH MAX CUT-OUT OF 26"W X 12"H X 22"D - WORKS W/RUBY3B & SUNCHSZ30

**PRODUCT DIMENSIONS**  
33-1/4" WIDTH x 14-1/4" HEIGHT x 25-3/4" DEPTH

**CUT-OUT DIMENSIONS**  
31-1/2" WIDTH x 13" HEIGHT x 24-1/4" DEPTH

**SLEEVE DIMENSIONS**  
26" WIDTH X 10" HEIGHT, REMOVE VENT PANEL FOR 12" MAX HEIGHT X 22"DEPTH

### PRODUCT DIMENSIONS

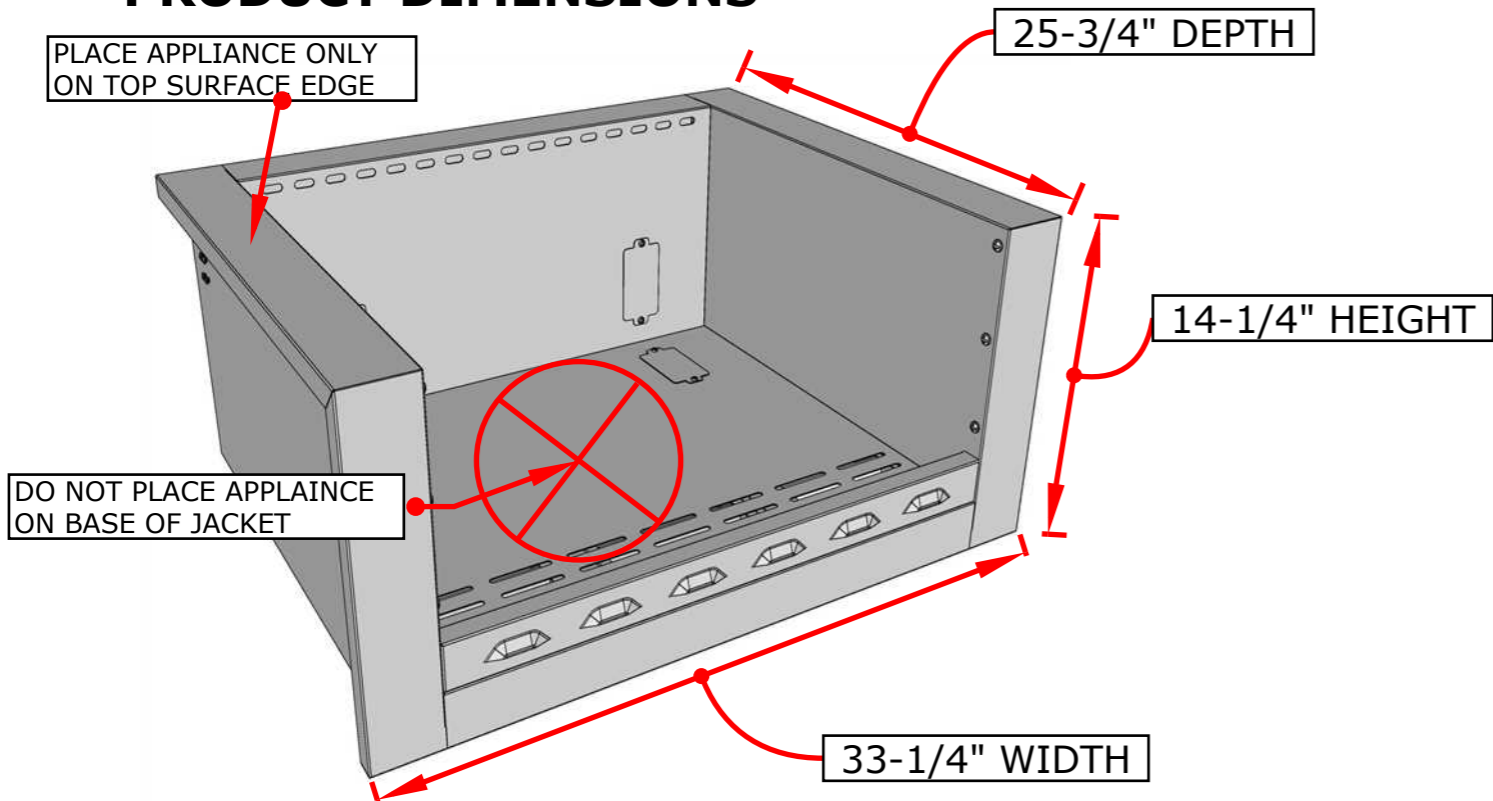

### CUT-OUT DIMENSIONS

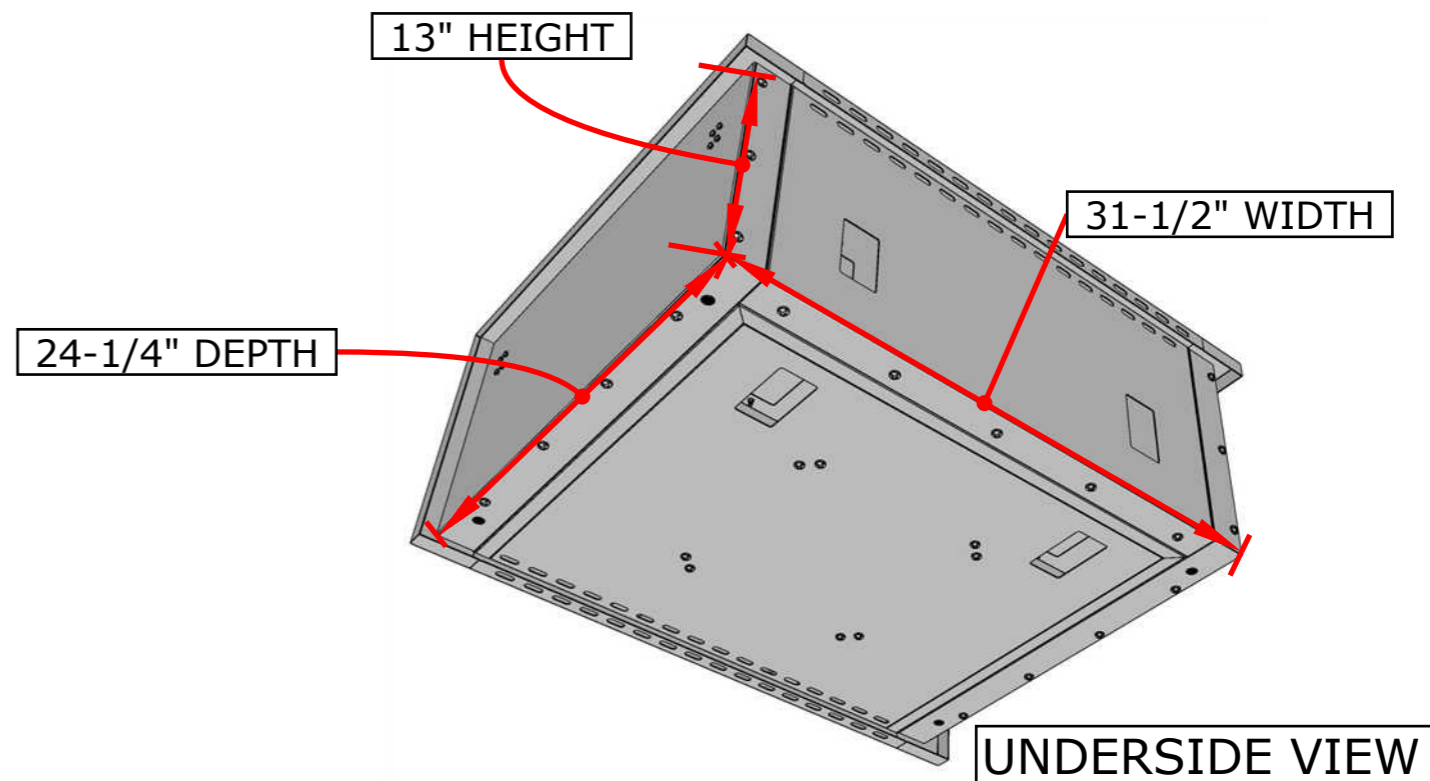

### ISLAND CUT-OUT DIMENSIONS

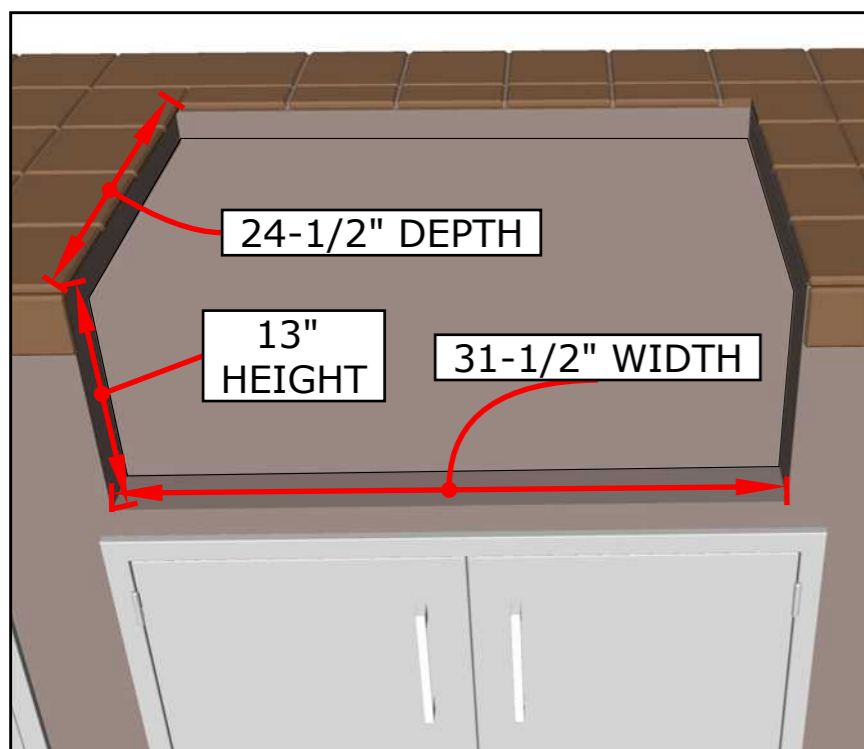

### JACKET SLEEVE DIMENSIONS

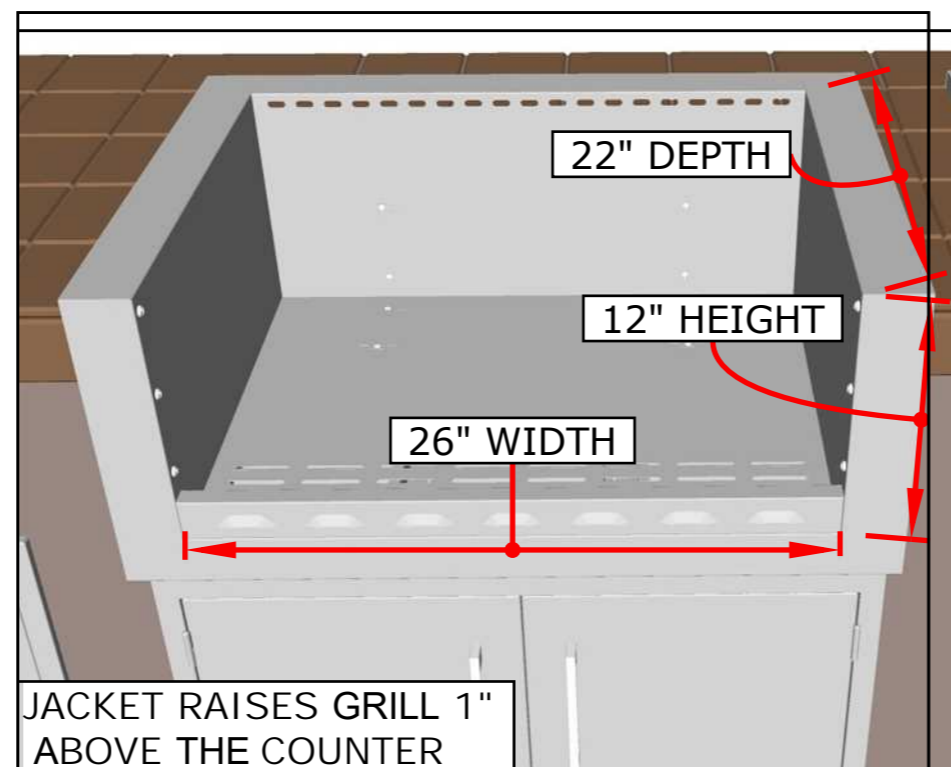

### APPLIANCE & JACKET RESULT

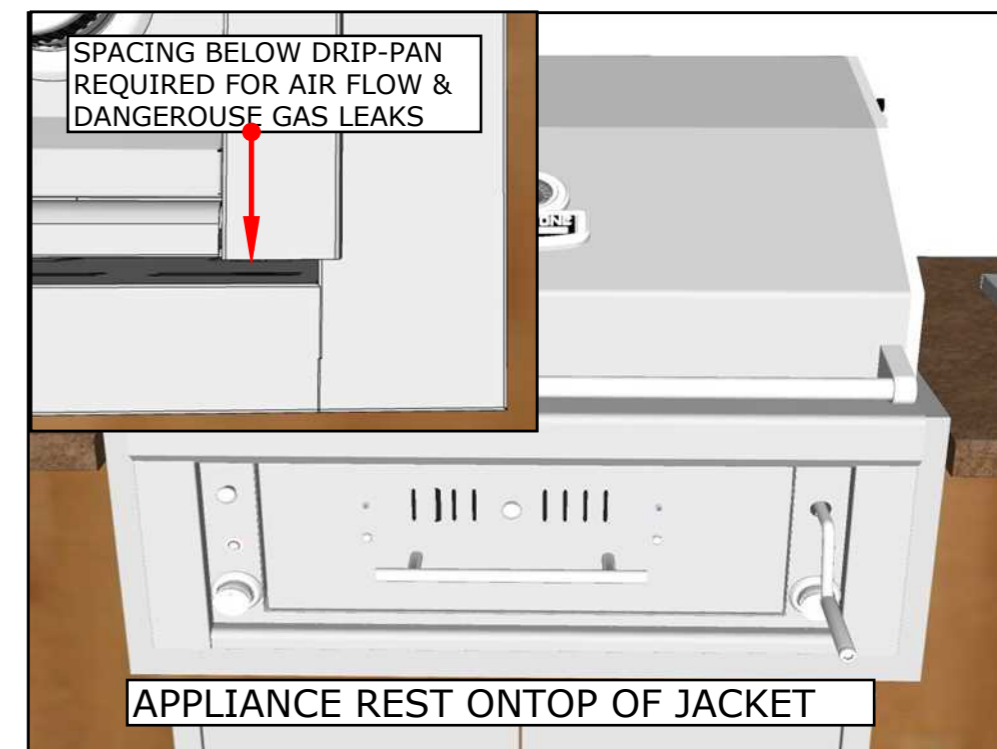



UNIVERSAL APPLIANCE JACKET

**PRODUCT**  
33" APPLIANCE JACKET  
  
**Item No.** SUNJK33

**DESCRIPTION**  
33" JACKET FOR GRILLS WITH MAX CUT-OUT OF 26"W X 12"H X 22"D - WORKS W/RUBY3B & SUNCHSZ30

**PRODUCT DIMENSIONS**  
33-1/4" WIDTH x 14-1/4" HEIGHT x 25-3/4" DEPTH

**CUT-OUT DIMENSIONS**  
31-1/2" WIDTH x 13" HEIGHT x 24-1/4" DEPTH

**SLEEVE DIMENSIONS**  
26" WIDTH X 10" HEIGHT, REMOVE VENT PANEL FOR 12" MAX HEIGHT X 22" DEPTH

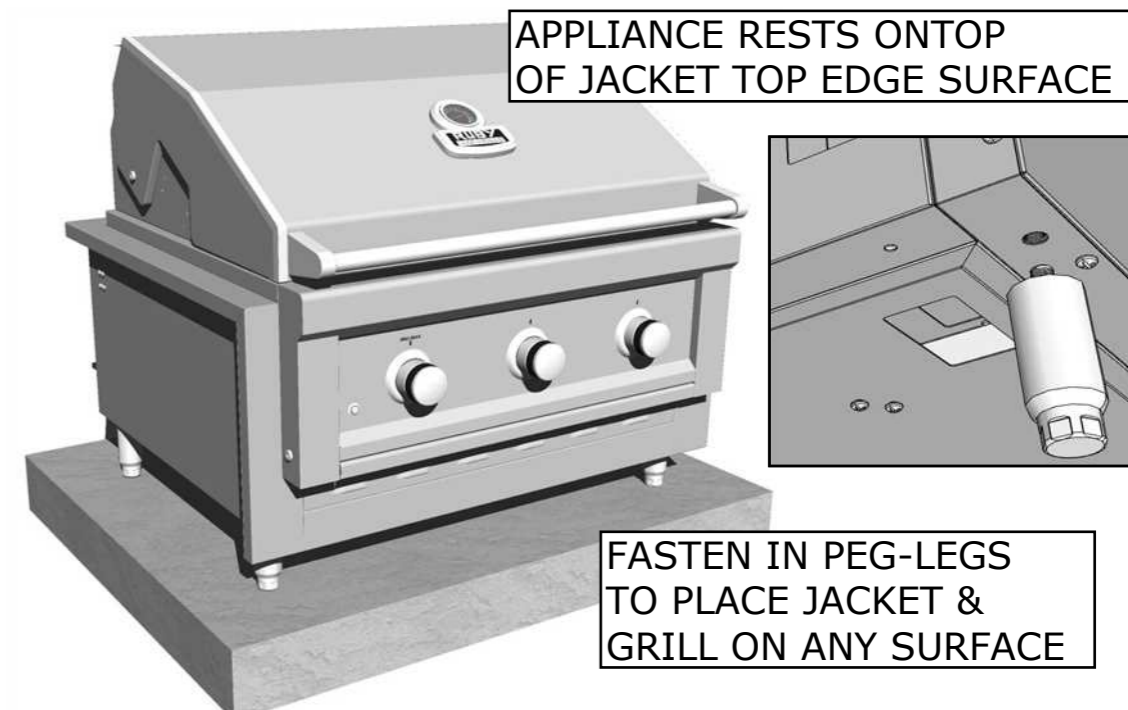
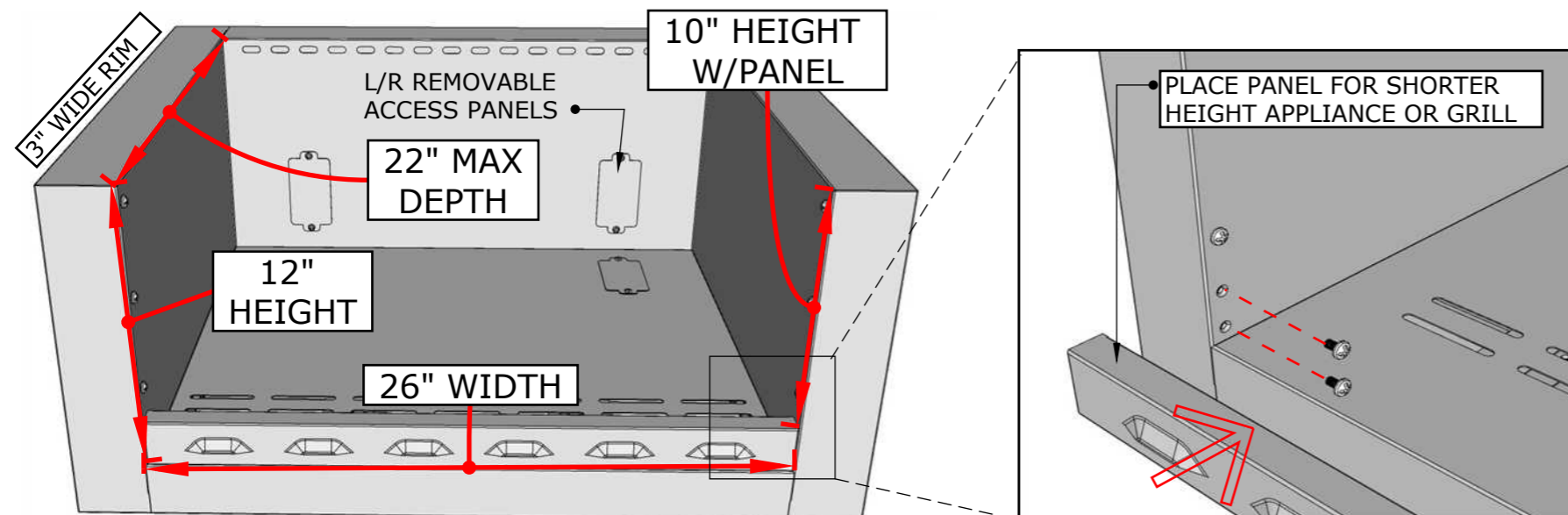

service@sunstonemetalproducts.com

**CALL OUR TECH. SUPPORT 888-934-9449**

Disclaimer: The trademarks used in the "Product Option" column below belong to their respective owners who do not sponsor nor are they affiliated with Sunstone Metal Products, L.L.C. The specific product Cut-Out Dimensions have not been directly confirmed by any Sunstone Metal Products LLC, representative or employee. Use own discretion to confirm exact product fit.

Model Number	Sleeve Cut-Out	Product Option
<b>SUNJK18</b>	12" WIDTH x 10" HEIGHT x 22" DEPTH OR 20-1/2" DEPTH W/PANEL INSTALLED	Sunstone® 13" Companion Pro - SUN13CPRO, Sunstone® 13" Double Burner - SUN13VDB, DCS® 14" Double Burner, Coyote® 13" Double Burner, Twin Eagles® 13" Double Burner, Fire Magic® Double Burner
<b>SUNJK29</b>	23" WIDTH X 10" HEIGHT, REMOVE VENT PANEL FOR 12" MAX HEIGHT X 22" DEPTH	Sunstone® 24" Power Cirque SUN24PCB, DCS® 24" Power Burner, DCS® 30" Burner w/Griddle, Coyote® 24" Power Burner, Hestan® Power Burner, Alfresco® 24" Versa Power, Blaze® 25" 3-Burner Grill
<b>SUNJK33</b>	26" WIDTH X 10" HEIGHT, REMOVE VENT PANEL FOR 12" MAX HEIGHT X 22" DEPTH	Sunstone® 28" Charcoal SUNCHDZ28, Sunstone® 30" Hybrid Grill SUNCHSZ30, Sunstone® 30" Ruby Grill RUBY3B, Blaze® 32" 4-Burner Grill, Fire Magic® Aurora® Grill, Coyote® 28" 2-Burner Grill
<b>SUNJK40</b>	34" WIDTH X 10" HEIGHT, REMOVE VENT PANEL FOR 12" MAX HEIGHT X 22" DEPTH	Sunstone® 36" 4-Burner Grill RUBY4B & RUBY4BIR, Coyote® 36" Charcoal Grill, Twin Eagles® 36" 3-Burner Grill
<b>SUNJK45</b>	39" WIDTH X 10" HEIGHT, REMOVE VENT PANEL FOR 12" MAX HEIGHT X 22" DEPTH	Sunstone® 42" Hybrid Grill SUNCHDZ42, Sunstone® 42" 5-Burner Grill RUBY5BIR, Blaze® 40" 5-Burner Grill, Napoleon® 42" 5-Burner Grill, Lion® 40" 5-Burner Grill, Coyote® 42" 5-Burner Grill, Fire Magic® 36" Gas Grill, Summerset® 38"(40") 4-Burner Grill, Bull® 38" 5-Burner Grill

