



User Manual

SPLIT AIR CONDITIONER

Before installing and using your TOSOT Air Conditioner, please read this user manual in its entirety.

MODEL NUMBERS

Indoor Unit	Outdoor Unit
SU-AORAKI9-115/I	SU-AORAKI9-115/O
SU-AORAKI9-230/I	SU-AORAKI9-230/O
SU-AORAKI12-115/I	SU-AORAKI12-115/O
SU-AORAKI12-230/I	SU-AORAKI12-230/O
SU-AORAKI18-230/I	SU-AORAKI18-230/O
SU-AORAKI24-230/I	SU-AORAKI24-230/O



Welcome to the TOSOT Direct Family!

We're extremely happy to welcome you as a new member of our family! Please read the tips below before using your product for the first time.

Tips for First-Time Use

1. The split-type air conditioner is a heavy object, which needs two or more people to lift and install. Failure to do so could result in injury or other accidents.
2. Allow the unit to sit upright for at least 3-4 hours before powering on. Shipping carriers may set the unit on its side, which causes the refrigerant to pool in certain areas. Standing the unit upright for 3-4 hours allows the refrigerant to move freely within the coils.
3. Some parts with sharp edges may cause injury, so gloves are highly recommended for unpacking and installing.
4. Run the unit continuously for 24 hours after installation. This allows the unit to work out any "kinks" that may have resulted during shipping from our factory to your doorstep.
5. If you have any problems with your product, please send us an email before submitting a return request, as there might be a simple solution for your issue.

Table of Contents

Safety Precautions	01
Warning	01
Caution	02
Electrical Safety Warning	03
The Refrigerant	03
Safety Operation of Flammable Refrigerant	04
Part List	10
Required Tools	11
Parts Description	12
Remote Control	13
Function Icons Description	14
Combination Buttons	21
App Control	25
Replacing the Batteries	26
Care and Maintenance	28
Precautions	28
Cleaning the Indoor Unit	28
Cleaning the Reusable Filter	29
Offseason Maintenance	30
Preseason Maintenance	30
Troubleshooting	31
Malfunction Codes	33

Quick Guide for Installation	34
Indoor Unit Installation	39
Select an Installation Site	39
Attach the Mounting Plate to the Wall	40
Connect the Wiring of the Indoor Unit	40
Connecting the Refrigerant Pipings	42
Drilling the piping hole on the wall	45
Mount the Indoor Unit	46
Extend the pipe by unwinding it	47
Outdoor Unit Installation	48
Select a Installation Site	48
Install the Drain Joint	49
Secure the Outdoor Unit	49
Connect the Refrigerant Pipe to Outdoor Unit	50
Note On Pipe Length	51
Refrigerant Piping Connection Instructions	51
Connect the Signal and Power Cables	54
Air Evacuation	57
Gas Leak Checks	58
Electrical Safety Checks	58
Test Run	59
Warranty & Customer Support	60
Warranty Information	60
Customer Support	60

Safety Precautions

Your safety and the safety of others are very important to us. Please read the following safety precautions before use and installation. A digital version can be obtained from customer support.

Warning

Failed to do the following instructions might cause the possibility of death or serious injury.

1. **Do not** connect the power before finishing installation.
2. **Do not** spray or wash the air conditioner with water to avoid electric shock or malfunction.
3. **Do not** insert fingers or objects into the air inlet or air outlet. It may cause personal injury or damage.
4. **Do not** block the air outlet or air inlet. It may cause malfunction.
5. Installation must be performed according to installation instructions and in accordance with the requirement of NEC and CEC by authorized personnel only. Improper installation may cause water leakage, electrical shock, fire, or may void the warranty.
6. Service or maintenance must be performed by authorized and qualified professionals. Otherwise, it may cause serious damage or personal injury or death.
7. Make sure the power supply is cut off before proceeding with any work related to electricity or general maintenance.
8. If the refrigerant leaks or requires discharge during installation, maintenance, or disassembly, it should be handled by certified professionals or otherwise in compliance with local laws and regulations.
9. The air conditioner must be properly grounded. The grounding resistance should comply with national electric safety regulations. Incorrect grounding may cause electric shock.
10. This appliance is not intended for use by persons (including children) with reduced physical, sensory or mental capabilities or lack of experience and knowledge, unless they have been given supervision or instruction concerning use of the appliance by a person responsible for their safety.

12. After removing the filter, do not touch the metal fins in order to avoid injury.

Caution

1. Please follow the instructions for installation and use of this product in this user manual.
2. The indoor unit should be installed close to the wall.
3. The appliance must be positioned so that the plug is accessible. The plug should be able to reach a properly-grounded wall outlet after finishing installation. Extension cords, power strips, or similar devices should not be used with this product.
4. The yellow-green wire in the air conditioner is grounding wire, which cannot be used for other purposes.
5. The temperature of the refrigerant circuit will be hot. Please keep wires and cables away from the copper refrigerant tube.
6. Do not spill water on the remote controller, otherwise the remote controller may be broken.
7. Do not use a hair dryer to dry the filter after washing to avoid deformation or fire hazard.
8. Do not step or put heavy objects on the top panel of the outdoor unit. It may cause damage or personal injury.
9. If any of the below issues occur, please turn off the air conditioner and disconnect power immediately. Contact us or qualified professionals for service.
 - a. Power cord is overheating or damaged.
 - b. There are abnormal sounds during operation.
 - c. Circuit breakers trips frequently.
 - d. Air conditioner gives off a burning smell.
 - e. Indoor unit is leaking.

Electrical Safety Warning

1. **Do not** share the same electrical socket with other appliances as this may create a fire hazard.
2. **Do not** cover the power cord with a rug or carpeting.
3. **Do not** rest hot or heavy objects on the appliance and power cord.
4. Never plug or unplug the appliance with wet hands.
5. Never unplug the appliance by pulling on the power cord.
6. According to the local safety regulations, use a qualified power supply circuit and circuit breaker and make sure the power supply matches with the requirement of the air conditioner. Unstable power supply may result in electric shock, fire hazard or malfunction.
7. All wires of indoor unit and outdoor unit should be in accordance with national wiring regulations.
8. If the power cord is damaged, it must be replaced by the manufacturer or an authorized technical service center.
9. Make sure the power supply is cut off when cleaning the air conditioner. Otherwise, it may cause electric shock.

The Refrigerant



Refrigerant
Safety Group
A2L

This appliance is filled
with flammable R-32 gas.



Before installing the appliance,
read this manual first.



Before using the appliance,
read this manual first.



Before repairing the appliance,
read this manual first.

- To realize the function of the air conditioner unit, a special refrigerant circulates in the system. The used refrigerant is the fluoride R32, which is specially cleaned. The refrigerant is flammable and odorless. Furthermore, it can lead to explosions under certain conditions. But the flammability of the refrigerant is very low. It can be ignited only by fire.
- Compared to other common refrigerants, R-32 is an environmentally friendly refrigerant that does not harm the ozone layer and has a lower greenhouse effect. Its excellent thermodynamic properties contribute to high energy efficiency, requiring less refrigerant and reduced maintenance.

WARNING

- This appliance is filled with flammable R-32 gas.
- Appliances should be installed, operated, and stored in a room with a floor area larger than X ft² (please refer to Table "A" in the section "Safety Operation of Flammable Refrigerants" for the required space X).
- The appliance should be stored in a room without active ignition sources such as open flames, an operating gas appliance, or an operating electric heaters.
- The appliance should be stored in a well-ventilated area, where the room size corresponds to the specifications for operation.
- Ducts connected to this appliance should not contain ignition sources.
- Keep any required ventilation openings clear of obstructions.
- Do not pierce or burn the appliance or any of its components.
- Be aware that refrigerants may be odorless, even when leaking.
- Only use manufacturer-recommended methods for defrosting or cleaning.
- Servicing shall be performed only as recommended by the manufacturer.
- Any repairs carried out by unqualified personnel may pose a danger.
- Compliance with national gas regulations must be observed.

Safety Operation of Flammable Refrigerants

Qualification of Workers

The qualification of personnel for maintenance, service, and repair operations should be according to UL 60335-2-40, CAN/CSA-C22.2 No. 60335-2-40:22 Annex HH.

Every procedure that affects safety shall only be carried out by competent persons as specified in Annex HH. Special training, in addition to usual refrigerating equipment repair procedures, is required when working with equipment containing flammable refrigerants.

Installation Notes

- The air conditioner must be installed in a room that is larger than the minimum room area. The minimum room area is shown on the nameplate or following Table A.
- It is not allowed to drill holes or burn the connection pipe.
- A leak test is a must after installation.

Table A - Minimum Room Area (ft²)

This table is based on UL 60335-2-40 requirements. The following installation heights and corresponding minimum room areas are provided for customer reference.

Charge Amount (lb)	Installation Height (ft)			
	5.9	7.2	8.2	9.8
	Minimum Room Area (ft ²)			
<4.0	/	/	/	/
4.0~6.0	105.5	87.2	76.4	63.5
6.2	109.8	90.4	79.7	66.7
6.4	114.1	93.6	81.8	68.9

Maintenance Notes

- Check whether the maintenance area or the room area meets the requirements specified on the nameplate.
 - It is only allowed to operate in rooms that meet the requirements specified on the nameplate.
- Check whether the maintenance area is well-ventilated.
 - The continuous ventilation status should be maintained during the operation process.
- Check whether there are any fire sources or potential fire sources in the maintenance area.
 - Naked flames are prohibited in the maintenance area, and the 'No Smoking' warning sign should be displayed.
- Check that the appliance markings are clear and in good condition.
 - Replace any vague or damaged warning signs.

Welding

- If you need to cut or weld the refrigerant system pipes during maintenance, please follow the steps below:
 - a. Shut down the unit and disconnect the power supply
 - b. Remove the refrigerant
 - c. Vacuum the system
 - d. Clean the system with N₂ gas
 - e. Cut or weld
 - f. Return to the service spot for welding
- The refrigerant should be recycled into a specialized storage tank.
- Make sure that there are no naked flames near the outlet of the vacuum pump and that the area is well-ventilated.

Filling the Refrigerant

- Use refrigerant filling appliances specialized for R32. Make sure that different kinds of refrigerants won't contaminate each other.
- The refrigerant tank should be kept upright while filling.
- Stick the label on the system after filling is finished (or not finished).
- Don't overfill.
- After filling is finished, please perform leakage detection before test running; another leak detection should be done when it's removed.

Safety Instructions for Transportation and Storage

- Please use a flammable gas detector to check before unloading and opening the container.
- No fire sources or smoking.
- According to the local rules and laws.

Safety of Construction

- For appliances using FLAMMABLE REFRIGERANTS, all joints made in the installation between parts of the REFRIGERATING SYSTEM, with at least one part charged, shall be made in accordance with the following:
 - A brazed, welded, or mechanical connection shall be made before opening the valves to permit refrigerant to flow between the REFRIGERATING SYSTEM parts. A vacuum valve shall be provided to evacuate the interconnecting pipe or any uncharged REFRIGERATING SYSTEM part.
 - Mechanical connectors used indoors shall comply with ISO 14903. When mechanical connectors are reused indoors, sealing parts shall be renewed. When flared joints are reused indoors, the flare part shall be refabricated.
 - Refrigerant tubing shall be protected or enclosed to avoid damage. Flexible refrigerant connectors (such as connecting lines between the indoor and outdoor units) that may be displaced during NORMAL OPERATION shall be protected against mechanical damage.

Pressure test and leak detect

- After completion of field piping for split systems, the field pipework shall be pressure tested with an inert gas and then vacuum tested prior to refrigerant charging, according to the following requirements.

The minimum test pressure for the low side of the system shall be the low side design pressure and the minimum test pressure for the high side of the system shall be the high side design pressure, unless the high side of the system cannot be isolated from the low side of the system in which case the entire system shall be pressure tested to the low side design pressure.
- Field-made refrigerant joints indoors shall be tightness tested. The test method shall have a sensitivity of 0.18 ounces per year of refrigerant or better under a pressure of at least 0.25 times the maximum allowable pressure. No leak shall be detected.

Notices for Using Refrigerant Sensor

- The refrigerant sensor can monitor whether R32 refrigerant leaks in real time. When a leakage of R32 refrigerant is detected, the sensor will trigger the alarm and emit a buzzer, and the indoor unit will display "EA" code. Meanwhile, the outdoor unit will stop running.

- In case of refrigerant leakage, please open the window immediately for ventilation to reduce the concentration of refrigerant in the room. Meanwhile, check the room to ensure that there is no fire source. After completing the above operations, please leave the room and go to a safe place, and then contact us for maintenance.
- When the refrigerant sensor reaches the end of its service life or is damaged, the indoor unit will display "FE" code. Please contact us to replace the refrigerant sensor.
- Avoid oil and water splashing onto the refrigerant sensor, otherwise it may cause damage to the refrigerant sensor.
- Avoid using it in environment with electromagnetic interference, chemical substances (such as chemical plants, etc.), flammable gas, combustible and explosive gas and smog, etc.
- Avoid using items containing ethanol (such as perfume) and smog-producing items (such as cigarettes) near the refrigerant sensor, otherwise it will lead to abnormal conditions such as false alarms. If such phenomenon occurs, please contact us for maintenance.
- Only applicable to refrigerant sensor models.

FCC WARNING

WARNING: Changes or modifications to this unit not expressly approved by the party responsible for compliance could void the user's authority to operate the equipment.

FCC STATEMENT

This device complies with Part 15 of the FCC Rules. Operation is subject to the following two conditions :

(1) this device may not cause harmful interference, and (2) this device must accept any interference received, including interference that may cause undesired operation.

NOTE: This equipment has been tested and found to comply with the limits for a Class B digital device, pursuant to part 15 of the FCC Rules. These limits are designed to provide reasonable protection against harmful interference in a residential installation. This equipment generates, uses, and can radiate radio

frequency energy and, if not installed and used in accordance with the instructions, may cause harmful interference to radio communications. However, there is no guarantee that interference will not occur in a particular installation. If this equipment does cause harmful interference to radio or television reception, which can be determined by turning the equipment off and on, the user is encouraged to try to correct the interference by one or more of the following measures:

- Reorient or relocate the receiving antenna.
- Increase the separation between the equipment and receiver.
- Connect the equipment to an outlet on a circuit different from that to which the receiver is connected.
- Consult the dealer or an experienced radio/TV technician for help.



IC STATEMENT









This device complies with Industry Canada licence exempt RSS standard(s). Operation is subject to the following two conditions: (1) this device may not cause interference, and (2) this device must accept any interference, including interference that may cause undesired operation of the device.

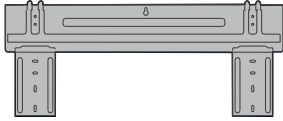





Le présent appareil est conforme aux CNR d'Industrie Canada applicables aux appareils radio exempts de licence. L'exploitation est autorisée aux deux conditions suivantes : (1) l'appareil ne doit pas produire de brouillage, et (2) l'utilisateur de l'appareil doit accepter tout brouillage radioélectrique subi, même si le brouillage est susceptible d'en compromettre le fonctionnement.

This equipment complies with FCC's and IC's RF radiation exposure limits set forth for an uncontrolled environment. The antenna(s) used for this transmitter must be installed and operated to provide a separation distance of at least 20 cm from all persons and must not be collocated or operating in conjunction with any other antenna or transmitter. Installers must ensure that a 20cm separation distance will be maintained between the device (excluding its handset) and users.

Cet appareil est conforme aux limites d'exposition au rayonnement RF stipulées par la FCC et l'IC pour une utilisation dans un environnement non contrôlé. Les antennes utilisées pour cet émetteur doivent être installées et doivent fonctionner à au moins 20 cm de distance des utilisateurs et ne doivent pas être placées près d'autres antennes ou émetteurs ou fonctionner avec ceux-ci. Les installateurs doivent s'assurer qu'une distance de 20 cm sépare l'appareil (à l'exception du combiné) des utilisateurs.

Parts List

PART	LOOKS LIKE	QUANTITY
Mounting Plate		1
Drywall Anchor		5
Mounting Plate Fixing Screw		5
Fixing Screw for Remote Controller Holder		2
Remote Control		1
Remote Control Holder		1
AAA Battery		2
Wall Cuff		1
Drain Joint		1

PART	LOOKS LIKE	QUANTITY
Refrigerant Pipe (16ft/5m)		1 set (Gas & Fluid)
Electrical Cable (16ft/5m)		1
Signal Cable (20ft/6m)		1
Sealing Gum		1
Drain Hose (6ft/2m) for Indoor Unit		1
Tape		2

Required Tools



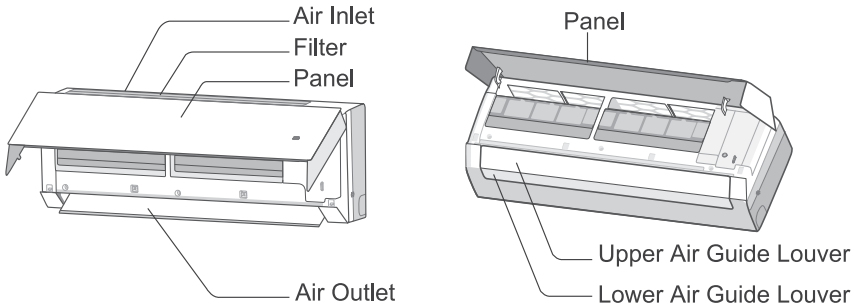

1. Bubble Level
2. Electric Drill with drill bit for pilot holes
3. Wire stripper/crimp tool
4. Screwdriver
5. Standard wrench
6. Open-end torque wrench
7. Drill with 2.2/2.8 inch hole saw
8. Vacuum pump

Parts Description

Indoor Unit



Display

Dry Mode		Temp. Indicator	26
Heat Mode		Power Indicator	
Cool Mode		Humidity Indicator	%

Note: This is the general introduction and the color of indicator is only for reference. Please refer to the actual display. Display content may be different from the actual. Please refer to the actual display.

Outdoor Unit

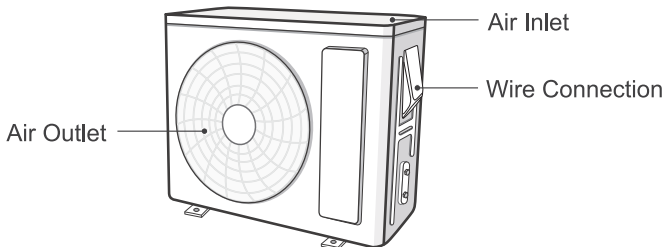

Note: This is a universal introduction for a variety of models. Display content may be different from the actual. Please refer to the actual unit.

Remote Control



Function Icons:

	Quiet	
	Set Fan Speed	
	Turbo Mode	
	Send Signal	
Operation Mode		Auto Mode
		Cool Mode
		Dry Mode
		Fan Mode
		Heat Mode
	X-FAN Function	
	Humidity Control	
	Indoor Ambient Temp.	
	Indoor Ambient Humidity	
	Set Temperature	
ON OFF	Timer On / Timer Off	
	Set Time	
	Left & Right Swing	
	Up & Down Swing	
	Child Lock	
	Fast Cool	
WIFI	WiFi Function	
	LED	
	Auto LED	
	I Feel Function	
	Sleep Mode	
	Two-way Ventilation Function	

ction

Note:

- This is a general use remote controller. It could be used for the air conditioner with multifunction. For the functions which the model doesn't have, if press the corresponding button on the remote controller, the unit will keep the original running status.

- After putting through the power, the air conditioner will give out a sound. Power indicator "⏻" is ON. After that, you can operate the air conditioner by using remote controller.
- Under on status, pressing the button on the remote controller, the signal icon "📶" on the display of remote controller will blink once and the air conditioner will give out a "di" sound, which means the signal has been sent to the air conditioner.
- As for the models with functions of WiFi or wired controller, the indoor unit must have been controlled by standard remote controller under auto mode first, and then the function of adjustable temperature under auto mode can be realized by APP or the wired controller.
- This remote controller can adjust the temperature under auto mode. When matching with the unit which is without the function of adjustable temperature under auto mode, the set temperature under auto mode may be invalid, or the displayed set temperature on the unit is not same as that on the remote controller under auto mode.

Function Icons Description

⏻ On/Off button





Press this button to turn on the unit. Press this button again to turn off the unit.

Mode button

Press this button to select your required operation mode.



- When selecting auto mode, air conditioner will operate automatically according to the sensed temperature. Press "Fan" button can adjust fan speed. Press "🌀" / "🌀" button can adjust fan blowing angle.
- After selecting cool mode, air conditioner will operate under cool mode. Press "+" or "-" button to adjust set temperature. Press "Fan" button to adjust fan speed. Press "🌀" / "🌀" button to adjust fan blowing angle.
- When selecting dry mode, the air conditioner operates at low speed under dry mode. Under dry mode, fan speed can't be adjusted. Press "🌀" / "🌀" button to adjust fan blowing angle.

- When selecting fan mode, the air conditioner will only blow fan, no cooling and no heating. Press "Fan" button to adjust fan speed. Press "  " / "  " button to adjust fan blowing angle.
- When selecting heat mode, the air conditioner operates under heat mode. Press " + " or " - " button to adjust set temperature. Press "Fan" button to adjust fan speed. Press "  " / "  " button to adjust fan blowing angle.

Note:







- For preventing cold air, after starting up heating mode, indoor unit will delay 1~5 minutes to blow air (actual delay time is depend on indoor ambient temperature).
- Set temperature can be adjusted under AUTO mode.
- Set temperature range from remote controller: 16~30°C (61-86°F).
- This mode indicator is not available for some models.

Fan button

This button is used for setting Fan Speed in the sequence that goes from AUTO,

 ,  ,  ,  ,  ,  ,  to  , then back to Auto.



 Quiet speed  Low speed  Low-Medium speed  Medium speed
 Medium-High speed  High speed  Turbo speed

Note:

- Under AUTO speed, air conditioner will select proper fan speed automatically according to factory default setting.
- It's low fan speed under dry mode.
- X-FAN function: Holding fan speed button for 2s in cool or dry mode, the icon "  " is displayed and the indoor fan will continue operation for a few minutes in order to dry the indoor unit even though you have turned off the unit. After energization, X-FAN OFF is defaulted. X-FAN is not available in auto, fan or heat mode.

This function indicates that moisture on evaporator of indoor unit will be blown after the unit is stopped to avoid mould.

- Having set X-FAN function on: After turning off the unit by pressing On/ Off button, indoor fan will continue running for a few minutes at low speed. In this period, hold fan speed button for 2s to stop indoor fan directly.
- Having set X-FAN function off: After turning off the unit by pressing On/Off button, the complete unit will be off directly.

+ / - button

Press "+" or "-" button once increase or decrease set temperature 1°C (°F). Holding "+" or "-" button, 2s later, set temperature on remote controller will change quickly. On releasing button after setting is finished, temperature indicator on indoor unit will change accordingly.

Wifi button



Press "Wifi" button to turn on WiFi function, "Wifi" icon will be displayed on the remote controller; Hold "Wifi" button for 5s to turn off WiFi function and "Wifi" icon will disappear. (This function is only available for some models.)

Under off status, press "Mode" and "Wifi" buttons simultaneously for 1s, WiFi module will restore factory settings.

Note:

- This function is only available for some models.

I Feel button





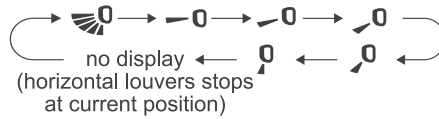

Press this button to start I Feel function and "" will be displayed on the remote controller. After this function is set, the remote controller will send the detected ambient temperature to the controller and the unit will automatically adjust the indoor temperature according to the detected temperature. Press this button again to close I Feel function and "" will disappear.

Please put the remote controller near user when this function is set. Do not put the remote controller near the object of high temperature or low temperature in order to avoid detecting inaccurate ambient temperature. When I Feel function is turned on, the remote controller should be put within the area where indoor unit can receive the signal sent by the remote controller.



UD-swing button

Press this button can select up & down swing angle. Fan blow angle can be selected circularly as below:



- When selecting "  ", air conditioner is blowing fan automatically. Horizontal louver will automatically swing up & down at maximum angle.
- When selecting " , , , ,  ", a ir conditioner is blowing fan at fixed position. Horizontal louver will stop at the fixed position.
- Hold "  " button above 2s to set your required swing angle. When reaching your required angle, release the button.

Note:

- Press this button continuously more than 2s, the main unit will swing back and forth from up to down, and then loosen the button, the unit will stop swinging and present position of guide louver will be kept immediately.
- Under swing up and down mode, when the status is switched from off to , if press this button again 2s later,  status will switch to off status directly; if press this button again within 2s, the change of swing status will also depend on the circulation sequence stated above.

Humidity button

Press this button can select up & down swing angle. Fan blow angle can be selected circularly as below:



- When humidity control with cooling mode is set, the remote controller will display "  ", and humidity value " 88 " and " % " icon will blink for 5s; you can press " + " and " - " buttons to set the humidity value within 5s.

Under humidity control with cooling mode, humidity setting range for the remote controller: 40%-80%. Temperature can be adjusted under humidity control with cooling mode.

- When smart dehumidification with cooling mode is set, the remote controller will display "☉"; the remote controller and indoor unit will display "Ao" for 5 seconds. Temperature can be adjusted under smart dehumidification with cooling mode.
- The humidity for smart dehumidification is automatically adjusted according to human body comfort; no need to set the humidity manually.

Under dry mode, press this button can select humidity control with dehumidification mode, continuous dehumidification mode, general dehumidification mode, and they can be set to operate circularly.



- When humidity control with dehumidification mode is set, the remote controller will display "☉", "% " and humidity value "88"; you can press "+" and "-" buttons to set the humidity value. Humidity setting range for the remote controller: 30%-70%. Temperature can't be adjusted under humidity control with dehumidification mode.
- When continuous dehumidification is set, the remote controller will display "☉"; the remote controller and indoor unit will display "Co". Temperature can't be adjusted under continuous dehumidification mode.
- Under continuous dehumidification mode, the unit always works under dehumidification status; no need to set temperature and humidity.

Note:



- The air conditioner is mainly used for controlling the temperature, while the humidity control is the auxiliary function. The humidity will be affected by the factors such as indoor and outdoor environment, degree of indoor sealing and indoor flow.
- When the set humidity is higher than current atmospheric humidity, the set humidity can't be reached.
If the humidity sensor is with malfunction, humidity setting under cooling mode or dehumidification mode will stop and the unit operates under general cooling mode or dehumidification mode.

LR-swing button

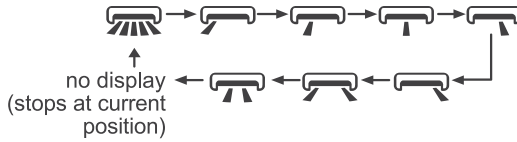
Press this button can select left & right swing angle. Fan blow angle can be selected circularly as below:



Note:

- Press this button continuously more than 2s, the main unit will swing back and forth from left to right, and then loosen the button, the unit will stop swinging and present position of guide louver will be kept immediately.
- Under swing left and right mode, when the status is switched from off to , if press this button again 2s later,  status will switch to off status directly; if press this button again within 2s, the change of swing status will also depend on the circulation sequence stated above.
- This function only applicable for some models.



Timer button

- At ON status, press this button once can set TIMER OFF. The character of HOUR and OFF will flash. Press "+" or "-" button within 5s can adjust the time of TIMER OFF. After each pressing of "+" or "-" button, time will increase or decrease half an hour. When holding "+" or "-" button, 2s later, the time will change quickly until to reach to your required time. After that, press "Timer" button to confirm it. The character of HOUR and OFF won't flash again.
Cancel TIMER OFF: Press "Timer" button again under TIMER OFF status.
- At OFF status, press this button once can set TIMER ON. Please refer to TIMER off for detailed operation.
Cancel TIMER ON: Press "Timer" button again under TIMER ON status.

Note

- Time setting range: 0.5-24 hours.
- Time interval between two operations can't exceed 5s. Otherwise, remote controller will exit the setting status automatically.

Sleep button

Press this button, can select Sleep 1 () , Sleep 2 () , Sleep 3 () and cancel the Sleep, circulate between these, after electrified, Sleep Cancel is defaulted.

- Sleep 1 is Sleep mode 1, in Cool modes: sleep status after run for one hour, the main unit setting temperature will increase 1, two hours, setting temperature increased 2, then the unit will run at this setting temperature; In Heat mode: sleep status after run for one hour, the setting temperature will decrease 1, two hours, setting temperature will decrease 2 , then the unit will run at this setting temperature.
- Sleep 2 is sleep mode 2, that is air conditioner will run according to the presetting a group of sleep temperature curve.
- Sleep 3 the sleep curve setting under Sleep mode by DIY;
 - (1) Under Sleep 3 mode, press "I Feel" button for a long time, remote controller enters into user individuation sleep setting status, at this time, the time of remote controller will display "1 HOUR", the setting temperature "88" will display the corresponding temperature of last setting sleep curve and blink (The first entering will display according to the initial curve setting value of original factory);
 - (2) Adjust " + " and " - " button, could change the corresponding setting temperature, after adjusted, press "I Feel" button for confirmation;
 - (3) At this time, 1hour will be automatically increased at the timer position on the remote control, (that is "2HOUR" or "3HOUR" or "8HOUR"), the place of setting temperature "88" will display the corresponding temperature of last setting sleep curve and blink;
 - (4) Repeat the above step (2)~(3) operation, until 8 hours temperature setting finished, sleep,curve setting finished, at this time, the remote controller will resume the original timer display; temperature display will resume to original setting temperature.
- Sleep 3 the sleep curve setting under Sleep mode by DIY could be inquired: The user could accord to sleep curve setting method to inquire the presetting sleep curve, enter into user individuation sleep setting status, but do not change the temperature, press " I Feel " button directly for confirmation. Note: In the above presetting or enquiry procedure, if continuously within 10s, there is no button pressed, the sleep curve setting within 10s, there is no button pressed, the sleep curve setting status will be automatically quit and resume to display the original displaying. In the presetting or enquiry procedure, press " On/Off " button, "Mode" button, "Timer" button or "Sleep" button, the sleep curve setting or enquiry status will quit similarly.

Light button

Press this button to control the LED status on the display, the circulation change is as follow:

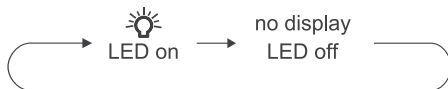

Combination Buttons

Energy-saving function



Under cooling mode, press "Mode" and "Timer" buttons simultaneously to start up or turn off energy-saving function. When energy-saving function is started up, "SE" will be shown on remote controller, and air conditioner will adjust the set temperature automatically according to ex-factory setting to reach to the best energy-saving effect.

Press "Mode" and "Timer" buttons simultaneously again to exit energy-saving function.

Note:

- Under energy-saving function, fan speed is defaulted at auto speed and it can't be adjusted.
- Under energy-saving function, set temperature can't be adjusted.
- Sleep function and energy-saving function can't operate at the same time. If energy-saving function has been set under cool mode, press "Sleep" button will cancel energy-saving function. If sleep function has been set under cool mode, start up the energy-saving function will cancel sleep function.

Child lock function

Hold " On/Off " and " - " buttons simultaneously for 3s to turn on or turn off child lock function. When child lock function is on, "  " icon is displayed on remote controller. If you operate the remote controller, the "  " icon will blink three times without sending signal to the unit.



Temperature display switchover function

Under OFF status, hold "Mode" and " - " buttons simultaneously for 3s to switch temperature display between °C and °F.

Indoor ambient temperature or humidity display

By holding " On/Off " and "  " buttons simultaneously , you can see indoor ambient temperature or indoor ambient humidity on indoor unit's display. The setting on remote controller is selected circularly as below:





- When selecting "  " with remote controller, temperature indicator on indoor unit displays indoor ambient temperature.
- When selecting "  " with remote controller, temperature indicator on indoor unit displays indoor ambient humidity.

Note

- The ambient humidity value is only for reference. Eg:
If humidity value is "0%", there may be malfunction for the humidity detection board. Please contact us.
- There may be some measuring deviation for humidity detection and photosensitiveness detection.

Clean reminder function of filter

The reminder function is defaulted to be OFF. Hold "On/Off " and "  " buttons simultaneously for 5s to turn it on. The buzzer will give out sound for 0.5s and the dual-8 nixie tube on the display will be on for 3s; Once the reminder function is turned on, when the air conditioner has reached to the set time, the dual-8 nixie tube will flash about 30s when the unit is turned on each time to remind the user to clean the filter; you can turn off this cycle reminder by holding " On/Off " and "  " buttons simultaneously for 5s and then the air conditioner will count time again.

Note

- Once the reminder function is turned on, only this cycle reminder can be cleared.
- This function is only available for some models.

Fast cool function

Press " On/Off " and " + " buttons simultaneously under cooling mode can select 25°C (77°F) fast cooling mode, 16°C (61°F) fast cooling mode and normal cooling mode circularly. " ❄️ " icon will be displayed on the remote controller under fast cooling mode.

Once it enters into fast cooling mode, the fan speed is auto fan and the set temperature is 25°C (77°F) or 16°C (61°F). At this time, the set temperature flashes to display for 5s. In the flashing period, press " + " or " - " button to adjust the set temperature.

Press "Fan" button to adjust the fan speed. If the set temperature and the fan speed haven't been adjusted during that time, the remote controller and the indoor unit will operate under current set temperature and fan speed for 20 minutes. 20 minutes later, the set temperature and the fan speed for the remote controller and the indoor unit will turn to the status before quick cooling.

Note

- If the set temperature and the fan speed have been adjusted during the operation under fast cooling mode, the unit will exit from the fast cooling mode.
- Then the indoor unit operates continuously under the adjusted status. Fast cooling function is only applicable for some models. If this function is unavailable for this indoor unit, 20 minutes later, the remote controller will turn back to the status before fast cooling. Indoor unit operates continuously according to current status. At this time, status of indoor unit and the display status on the remote controller may be different.
- This function is only available for some models.

Auto clean function

Under unit off status, hold "Mode" and " 🌀 " buttons simultaneously for 5s to turn on or turn off the auto clean function. When the auto clean function is turned on, indoor unit displays "CL". During the auto clean process of evaporator, the unit will perform fast cooling or fast heating. There may be some noise, which is the sound of flowing liquid or thermal expansion or cold shrinkage. The air conditioner may blow cool or warm air, which is a normal phenomenon. During cleaning process, please make sure the room is well ventilated to avoid affecting the comfort.

Note

- The auto clean function can only work under normal ambient temperature. If the room is dusty, clean it once a month; if not, clean it once every three months. After the auto clean function is turned on, you can leave the room. When auto clean is finished, the air conditioner will enter standby status.
- This function is only available for some models.

Night mode



Under cooling or heating mode, when turning on sleep mode and turn to low speed or quiet notch, the outdoor unit would enter into night mode.

Note

- When you feel that the cooling and heating effect is poor, please press "Fan" button to other fan speed or press "Sleep" button to exit the night mode.
- The night mode can only work under normal ambient temperature.
- This function is only available for some models.

App Control

Supported Equipment

Smart Phone System	Wireless Routers
 iOS 7.0 & above version	 must work with operating frequency: 2.4GHz
 Android 4.4 & above version	

Installation and Setup

1. Scan the QR code or search for "GREE+" or "TOSOT+" in the App Store or Google Play Store.



2. Open the "GREE+" or "TOSOT+" App after installation. You can create a new account or log in with an existing account.
3. Add a device by tapping the "+" button as shown in the picture. The app will automatically start searching for devices. Press the "WiFi" button on the remote control to turn on the WiFi function.

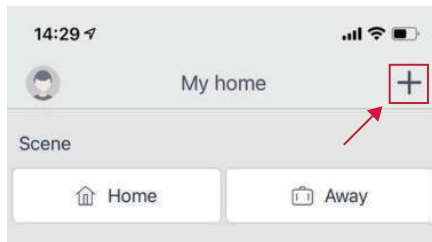

*Please make sure the "wifi" indicator is light on in the remote control.

4. Tap the available device icon and select your Wi-Fi network. Enter your WiFi password, then tap the "Next" button.
5. Once the device is added successfully, you will return back to the "My home" page. Select your appliance to start app control.

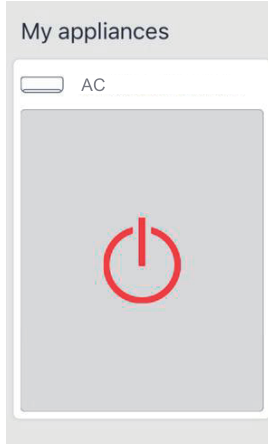

**If you have problems,
please refer to "Help" in the app or contact our support team.**

Replacing the Batteries

- Press the back side of the remote control battery cover and slide out following the engraved arrow.
- Replace with two new AAA(1.5V) batteries of the same make and model. Make sure the polarities (+ & -) are aligned correctly.
- Reinstall the battery cover box.

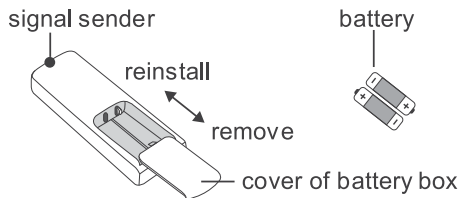

Notice

- During operation, point the remote control signal sender at the receiving window on the indoor unit.
- The distance between the signal sender and the receiving window should be no more than 26ft/8m, and there should be no obstacles between them.
- The signal may be easily interfered with in a room where there is a fluorescent lamp or a wireless telephone; the remote controller should be close to the indoor unit during operation.
- Replace the batteries with new ones of the same model when replacement is required.
- When you don't use the remote controller for a long time, please take out the batteries.
- If the display on the remote controller is fuzzy or there's no display, please replace the batteries.

Care and Maintenance

Precautions

- **Disconnect from** power before cleaning and servicing. Failure to do so may cause electric shock.
- **Do not** wash the air conditioner with water as this may cause electric shock.
- **Do not** use volatile liquids (such as paint thinner or gas) to clean the air conditioner. This may damage the appearance of the air conditioner or cause parts to deteriorate.
- **Do not** use liquid or corrosive detergent to clean the appliance and do not splash water or other liquid onto it as this may damage plastic components or cause electric shock.

Cleaning the Indoor Unit

If there's dust on the surface of the outer case please use a soft cloth to wipe it clean. You might need to use mild detergent for cleaning.

Cleaning the Reusable Filter

1. Remove filter

Press the spring fasteners at both sides in the direction indicated by the arrows. Meanwhile, lift up the filter so that it is separated from the fasteners. Pull the filter forward and remove it.

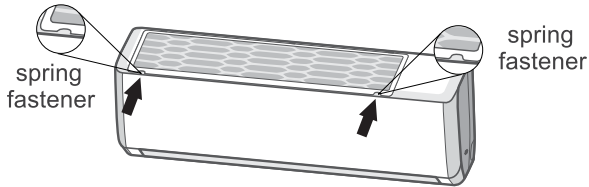

2. Clean filter

Use clear water to wash it or dust catcher to clean it. If the filter is very dirty (such as grease), use warm water (45°C) dissolved with neutral detergent to clean it, and then put it at the shady place to dry it.

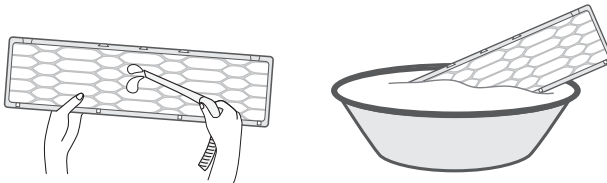

3. Install filter

After cleaning, reinstall the filter in reverse order. Push it along the guide rails at both sides and then press the left and right edges of the filter. Refit the filter in the direction indicated by the arrows.

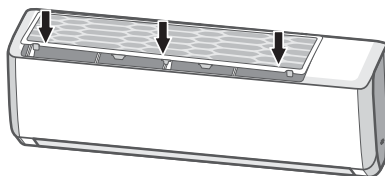

Note:

- Clean the filter at least once per month.
- Do not touch the metal fins in the air conditioner after removing the filter as they may cause injury.
- Do not attempt to dry the filter with a hairdryer or other heating elements as this may deform or ignite the filter.
- Do not operate the air conditioner if the air filter is missing.

Offseason Maintenance

If you are going to put the unit into long-term storage, please do the following:

1. Disconnect from power supply.
2. Clean filter and outer case.
3. Remove dust and debris on the air conditioner.
4. Turn on the FAN mode for at least 8 hours to dry the indoor unit out completely.

Preseason Maintenance

If you are going to use the unit again after a long period of non-use, please do the following:

1. Check whether air inlets and air outlets are blocked.
2. Check whether plug and socket are in good condition.
3. Check whether the filter is clean.
4. Check whether batteries are installed in the remote control.
5. Check whether the unit is leaking any refrigerant or water.

Troubleshooting

You may meet some common issues listed below. We recommend you do a self check first, but if the problem is not resolved, please contact customer support at support@tosotdirect.com.

Issues	Self check	Solutions
No air emitted from the indoor unit	Is the air inlet or outlet of the indoor unit blocked?	Remove the obstacles.
	If using the heating and cooling mode, has the indoor temperature reached the set temperature?	Once the ambient indoor temperature reaches the set temperature, the indoor unit will stop blowing out air.
	Did you just turn the heating mode on?	After starting the heat mode the indoor unit will delay 1-5 minutes before blowing air.
Air conditioner will not operate	Power failure?	Wait after power recovery.
	Is the plug loose?	Reinsert the plug.
	Circuit breaker trips or fuse blown?	Contact customer support or qualified professionals.
	Did you just restart the unit after powering it off?	The unit is experiencing the 3-Minute Compressor Protection to help extend the lifespan of your unit. Wait for 3min, and then turn on the unit again.
	Are batteries in the remote control exhausted?	Replace with two new AAA(1.5V) batteries.
	Are batteries in the remote control installed properly?	Make sure the polarities (+ & -) are aligned correctly.

Issues	Self Check	Solutions
White mist emitted from indoor unit	Are the indoor temperature or humidity levels high?	In humid regions, a large temperature difference between the room's air and the conditioned air can cause white mist. After a while, indoor temperature and humidity will decrease and the mist will disappear.
Strange odours emitted	Check whether there's odour source such as new furniture or smoking, etc.	Remove the odour source and clean the reusable filter.
Set temperature can't be adjusted	Unit is running under auto mode?	Temperature can't be adjusted under auto mode.
	Your desired temperature exceeds the set temperature range?	Temperature setting range: 61°F(16°C) - 86°F(30°C).
Poor cooling or heating performance	Is the air filter dirty?	Clean the air filter.
	Are the temperature and mode settings proper?	Adjust the temperature setting and mode.
	Is direct or strong sunlight shining into the room during cooling?	Close windows and curtains during periods of high heat or bright sunshine.
	Are doors and windows open to the room?	Make sure all doors and windows are closed.
Operation is unstable and abnormal	Check if there's interference such as cell phone towers, thunder, wireless devices, etc.	Disconnect power, wait 30 seconds and restart, then turn on the unit again.
Abnormal noises	Air conditioner was just turned on or turned off?	Low hissing sound when the system starts, has just stopped running, or is defrosting. This noise is normal and is caused by the refrigerant gas stopping or changing direction.

Issues	Self check	Solutions
Abnormal noises	Air conditioner was just turned on or turned off or adjusted temperature?	Cracking sound: Normal expansion and contraction of plastic and metal parts caused by temperature changes during operation.

- If you notice or experience any of the following conditions, please turn off the air conditioner, disconnect from power, discontinue use, and contact support immediately.
 - The power cord is overheating or otherwise damaged
 - Abnormal sound during operation
 - A strange odor is emitted from the unit
 - Excessive water leakage the unit
- Do not attempt to repair or retrofit the air conditioner by yourself. All repairs must be performed by qualified individuals.

Malfunction Codes

Error Code	Malfunction Name	Solutions
F0	Refrigerant leakage protection	Refill the refrigerant.
F1, F2, F4	Temperature sensor malfunction	Remove the unit from power for a few minutes. Plug the unit back in to determine if the malfunction code is still present.
H3, E8	Overload protection	
E2	Antifreezing protection	
E5	Overcurrent protection	1. Check and make sure the supply voltage is stable and consistent with the rated range. 2. Check if the inlet/outlet is blocked, remove the blockage.
E6	Communication malfunction	Reconnect the line according to wiring diagram.
H6	Internal fan motor do not operate	After powering off, turn the fan blades by hand to ensure the blades are running smoothly.
P5, H5	IPM protection	1. Check if the filter or the inlet/outlet is blocked, remove the blockage. 2. The temperature sensor or the mainboard is broken.
PL	Voltage of DC bus-bar is too low	Measure the voltage of position L and N on wiring board, if the voltage is higher than 150V, turn on the unit after the supply voltage is increased to the normal range.

Quick Guide for Installation

These are basic instructions to help you quickly set up your unit. For a more detailed explanation, please read the Indoor Unit Installation (page 39) and Outdoor Unit Installation (page 48):

Indoor Unit:

1

Select an Installation Site

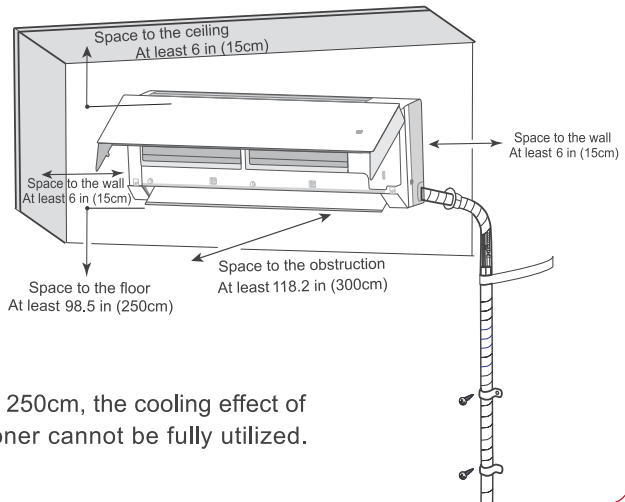

2

Attach the Mounting Plate to the Wall

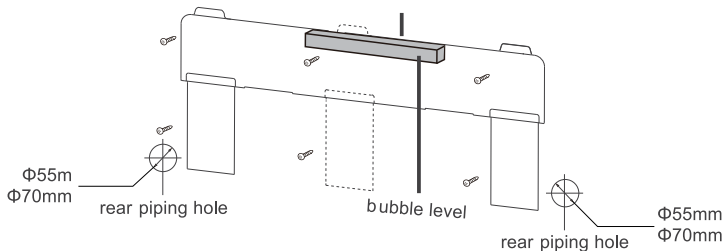

3

Connect the Wiring

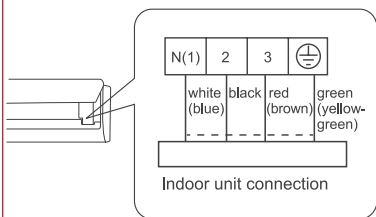

4

Connect the Piping

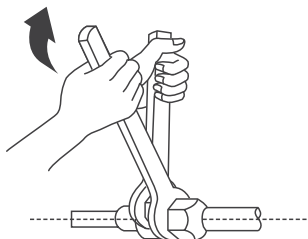

5

Connect the Drain Hose

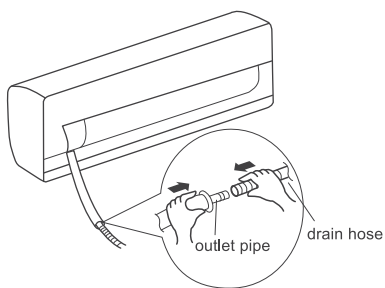

6

Wrap the Piping

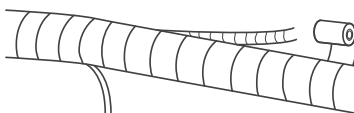

7

Drill Wall Hole

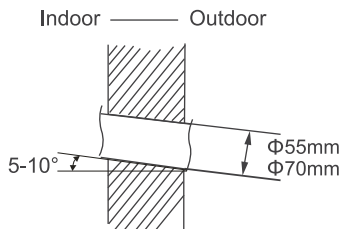

8

Mount the Indoor Unit

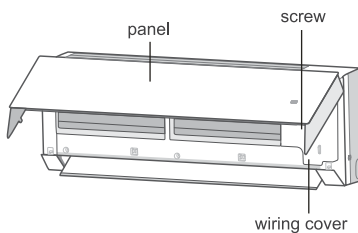

9

Secure the Remote Control Holder

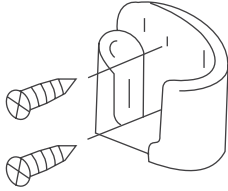

Outdoor Unit:

1

Select a Installation Site

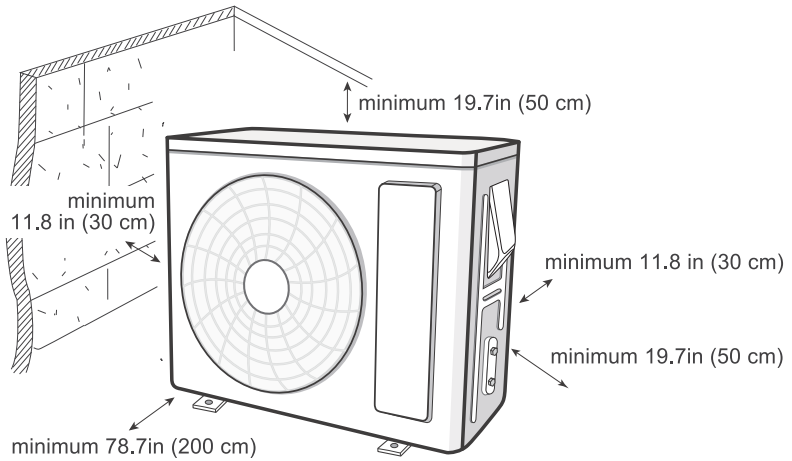

2

Install the Drain Joint

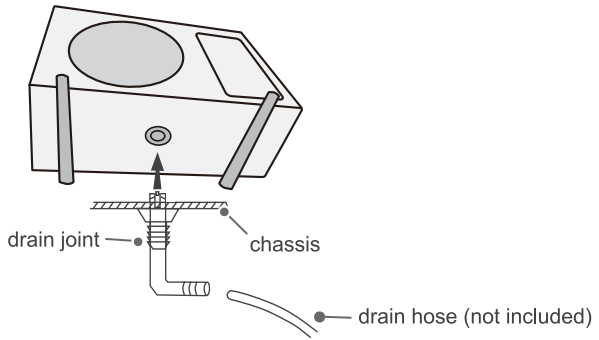

3

Secure the Outdoor Unit

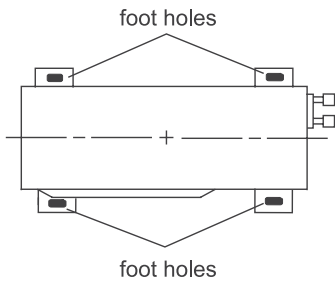

4

Connect the Refrigerant Pipe

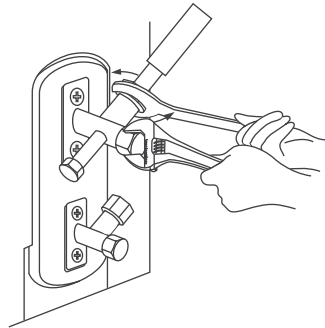

5

Connect the Signal and Power Cables

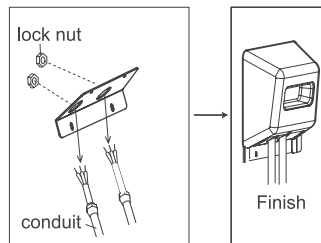
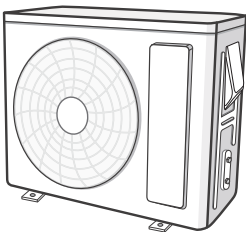

6

Air Evacuation

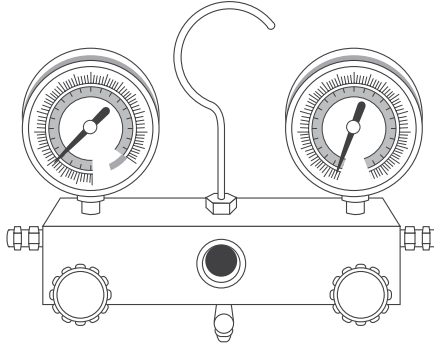

7

Gas Leak Checks

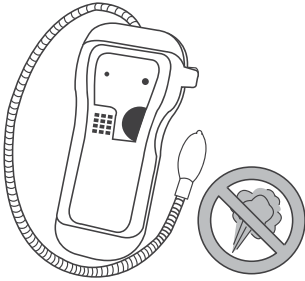

8

Electrical Safety Checks

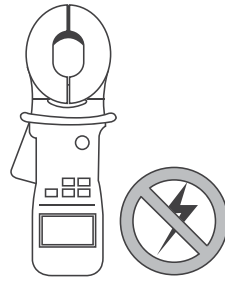

Indoor Unit Installation



Before installing the indoor unit, you need to check the label on the product box and make sure that the model number of the indoor unit matches the model number of the outdoor unit.

1. Select an Installation Site

Refer to the following diagram to ensure proper distance from walls and ceiling:

- If placed under 250cm, the cooling effect of the air conditioner cannot be fully utilized.

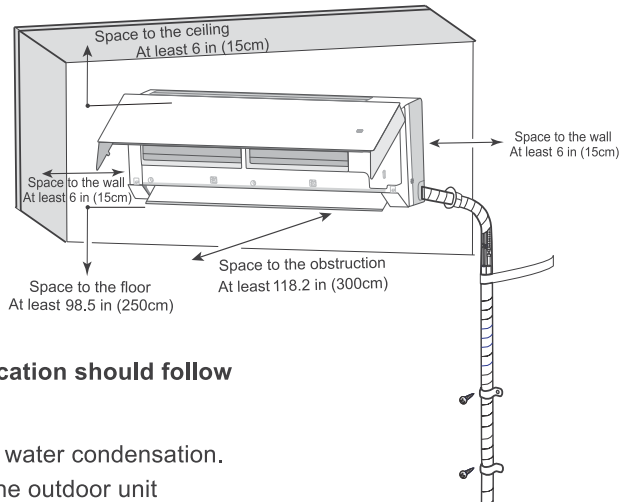

An appropriate install location should follow these standards:

- Convenient drainage for water condensation.
- Convenient to connect the outdoor unit
- Near a properly-grounded wall outlet
- Not easily accessible for children.
- Strong enough to support the weight of the unit.
- Away from other electric appliances (e.g. TV, radio, computer, etc.)
- Not near fluorescent lamps.

DO NOT install the unit in the following locations:

- Near strong heat sources or where vapors, flammable or explosive gas, or volatile objects can be spread in the air.
- Near high-frequency devices such as welding machines or medical equipment.
- Corrosive environments such as the laundry room or swimming pool.
- Any filled with oil, sulfurated gas or fumes in the air.

2. Attach the Mounting Plate to the Wall

The mounting plate is where you will mount the indoor unit.

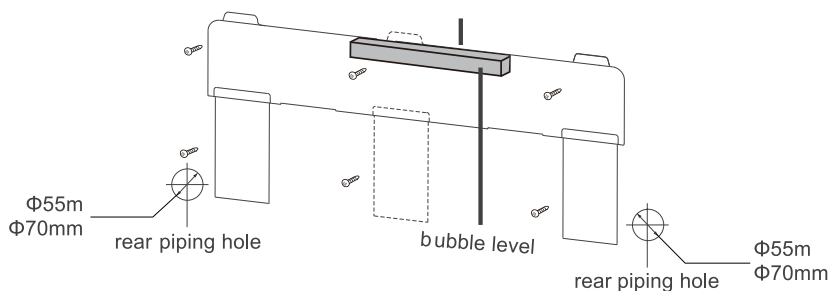

- Hold the mounting plate against the wall and adjust the plate using a bubble level until perfectly level.
- Mark screw holes on the wall and drill pilot holes with a drill. You may need a stud finder to find wooden studs to securely anchor the mounting plate. Do not just drill holes through drywall as this is not strong enough to support the indoor unit.
- Secure the mounting plate to the wall with the provided screws until the mounting plate is firmly attached to the wall.

3. Connect the Wiring of the Indoor Unit

Notice: All wiring of the indoor and outdoor units should be completed by a professional electrician or HVAC installer.

- Open the front panel of the indoor unit and use a screwdriver to pry open the wiring cover located on the right side. This will reveal the terminal block.

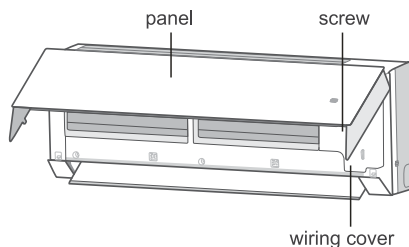

- Using wire strippers, remove the rubber insulation from both ends of the signal cable in the lineet to reveal approx. 6 inches (15cm) of wiring.
- Using a crimp tool, crimp U-Type lugs (not included) on both ends of the wires.
- Feed the power connection wire from the rear right of the unit through the cable cross hole and pull it through from the front of the unit.

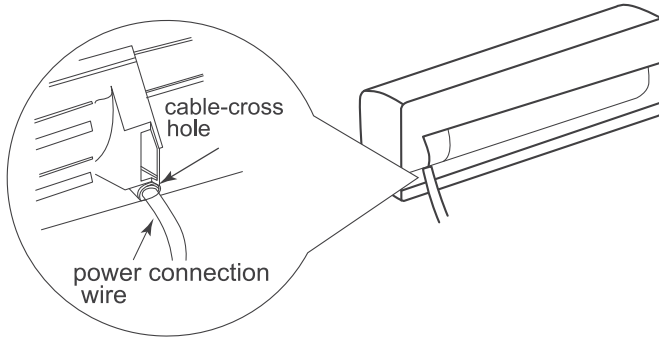

- Match the colored wires to the correct labels on the terminal block. Connect the power connection wire and firmly screw each wire to its corresponding terminal.

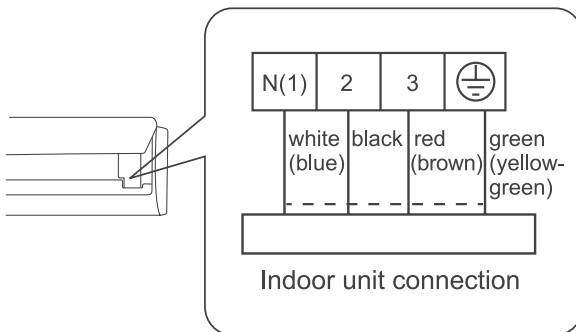

NOTE: Make sure the connection is following the instruction.

- After ensuring that each connection is secure, tightly screw down the cable clamp.
- Snap the wiring cover back into place and shut the front panel.

4. Connecting the Refrigerant Piping

- Align both ends of the refrigerant pipings and start to twist on the union nut by hand.
- Use a standard wrench on the pipe joint and an open-end torque wrench on the union nut to apply the proper torque as shown in the torque table below.

Note: If the union nut is too loose it will cause leaks. Over-tightening may damage connections and cause leaks. Carefully tighten the union nut to the correct torque level referring to the Torque Table below. If you need help on this step, please contact customer support.

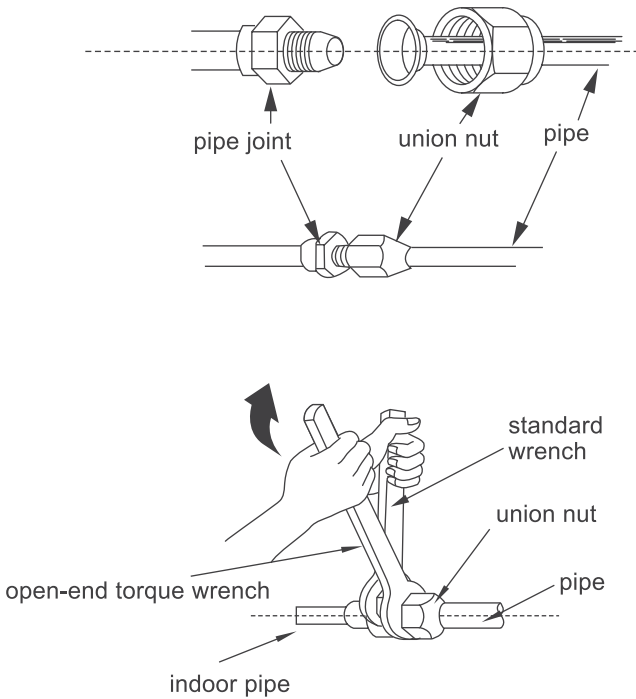

Torque Table

Pipe Diameter	Nut Size	Tightening Torque	
		ft-lbs	N-m
1/4 (6)	1/4 (17)	12 to 14	15 to 20
3/8 (9.5)	3/8 (22)	23 to 29	30 to 40
1/2 (12.7)	1/2 (25)	34 to 40	45 to 55
5/8 (16)	5/8 (29)	45 to 47	60 to 65

- In some models, both sides of the indoor unit are provided with drainage ports so you can choose one of them to attach the drainage hose. Plug the unused drain port with the rubber attached to one of the ports.

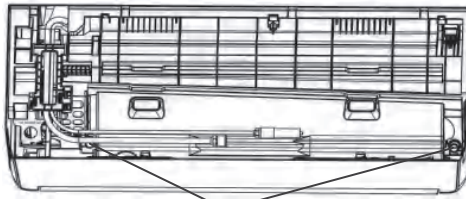

drainage ports

- Connect the drain hose to the outlet pipe of the indoor unit and secure the joint with tape.

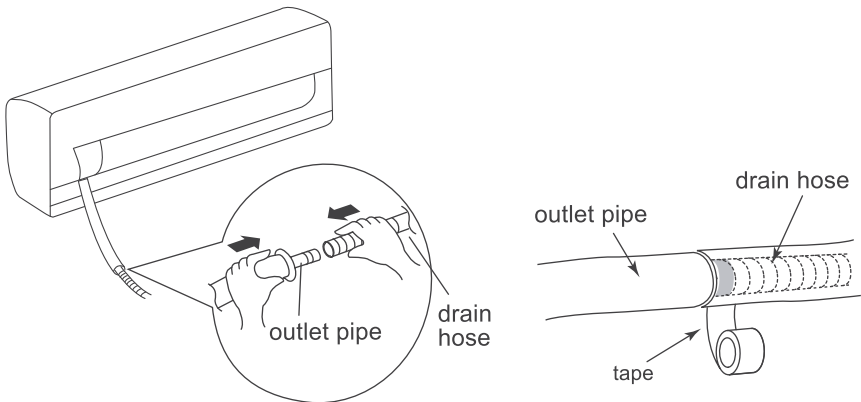

- Wrap the joints with the included insulating material to prevent condensation.

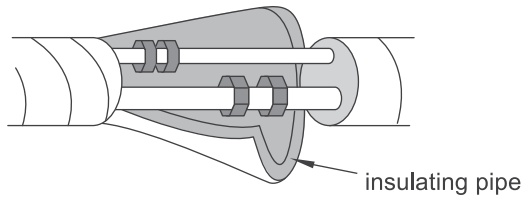

- Wrap the refrigerant pipes, electrical cables, and drain hose with tape so it looks like the below figure

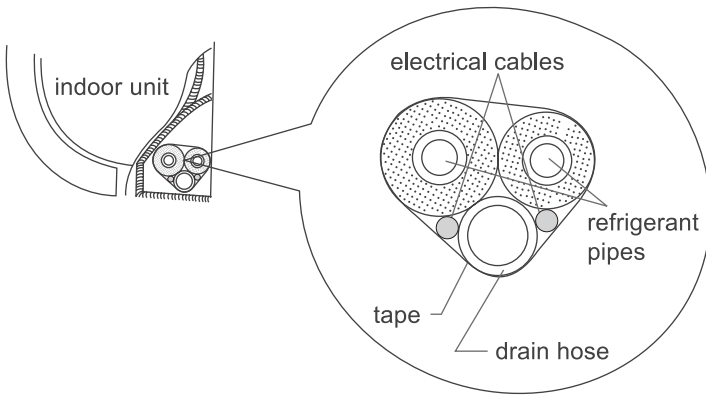

- Reserve a few inches of drain hose and power cable. When wrapping to a certain length, separate the indoor power cord and then separate the drain hose.

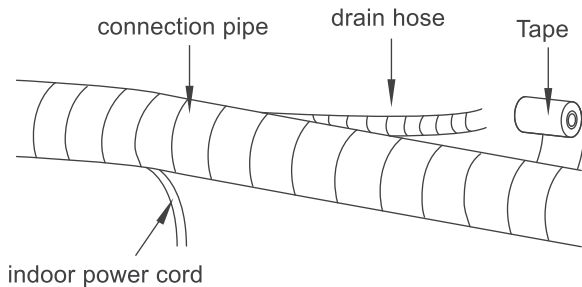

Note: When wrapping the bundle, keep the ends of the piping unwrapped. You need to access them to test for leaks at the end of the installation process.

5. Drilling the Piping Hole on the Wall

You must drill a hole in the wall for the wrapped bundle of pipes to connect the indoor and outdoor units.

- Choose an appropriate location for the piping hole based on the position of the mounting plate and the direction of the pipe. There are four directions you could choose:
 1. Out of the right side of the indoor unit
 2. Out of the rear right side of the indoor unit
 3. Out of the rear left side of the indoor unit
 4. Out of the left side of the indoor unit

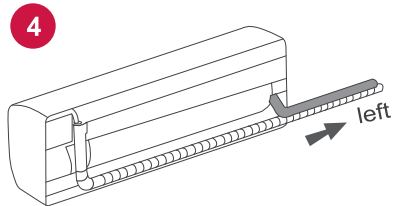
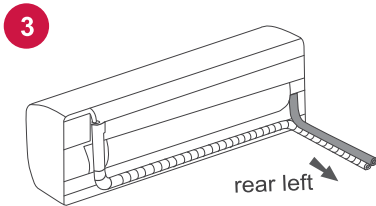
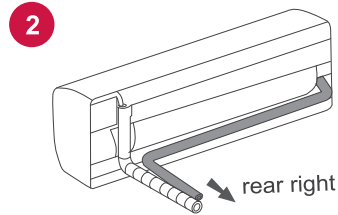
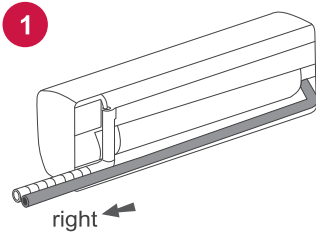

Be extremely careful not to dent or damage the piping while bending them away from the unit. Any dents in the piping will affect the unit's performance.

- If you choose a pipe direction out of the left or right side of the indoor unit, you will need to knock out the corresponding hole on the bottom of the side panel.

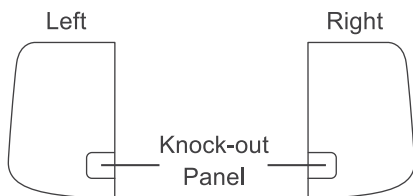

- Drill a hole with a 2.2/2.8 inch (55/70 mm) diameter through the wall where you want the pipe to go through. To ensure better drainage, slope the hole at a slight 5-10 degree angle downwards. The hole should be drilled lower than the mounting plate, as shown in the example figure below.

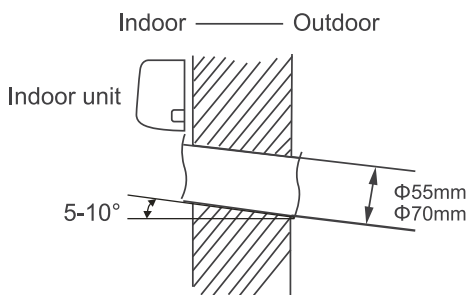

- Place the protective wall cuff in the hole. This protects the edges of the hole and will help seal the hole when you finish installation.

6. Mount the Indoor Unit

- Insert the wrapped bundle of pipes and cables through the hole you just drilled. Use some of the included sealing gum if there are any gaps between the bundle and the wall hole.
- Mount the indoor unit onto the mounting plate.
- Make sure the indoor unit is securely mounted by applying pressure to the left and right sides of the unit.

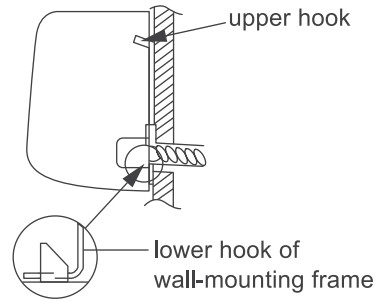
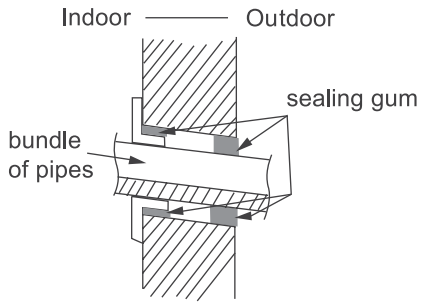

7. Extend the Pipe by Unwinding It

- Extending the pipes should be clung to the wall, bent slowly. The minimum radius of bending the pipe should not exceed 4 in (10 cm).
- If the pipe is repeatedly bent or extended, it will become hard and difficult to manipulate. Avoid bending or extending the pipe for more than 3 times.
- Make sure the pipe connector is protected from dirt and debris when the pipe passes through the wall. Covering the connections with tape could do the trick.

Outdoor Unit Installation

1. Select a Installation Site

Refer to the following diagram to ensure proper space around the unit:

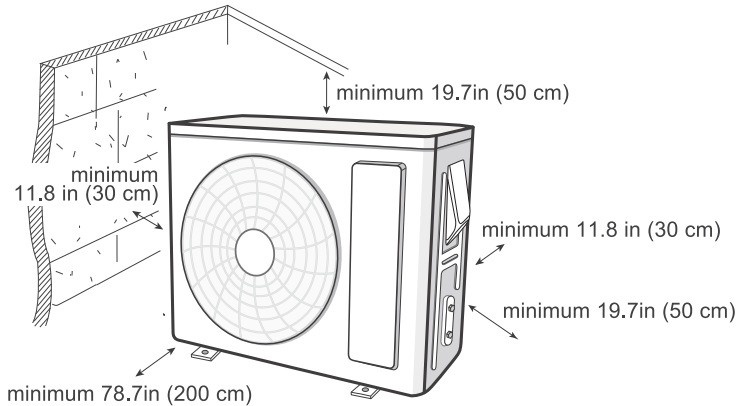

Appropriate install locations should follow these standards:

- Open ventilation space around the air conditioner to ensure airflow.
- Location must be convenient to install and not disturb others.
- Protected from prolonged periods of direct sunlight exposure.
- Strong enough to support the weight of the unit.

DO NOT install the unit in the following locations:

- Near an obstacle that will block air inlets and outlets.
- Near a public street, crowded areas, or where noise from the unit will disturb others.
- Near animals or plants that will be harmed by hot air discharge.
- Near any source of combustible gas or area that is exposed to large amounts of dust.
- Near excessive amounts of salty air.

Note: If the unit is frequently exposed to heavy rain or snow. Build a shelter above the unit to protect it. Be careful not to obstruct airflow around the unit.

2. Install the Drain Joint

Heat pump units require a drain joint if the unit is elevated off the ground. Before bolting the outdoor unit in place, you must install the drain joint at the bottom of the unit.

- Connect the outdoor drain joint into the hole in the base pan of the unit, as shown in the picture below.
- Connect the drain hose into the drain joint.

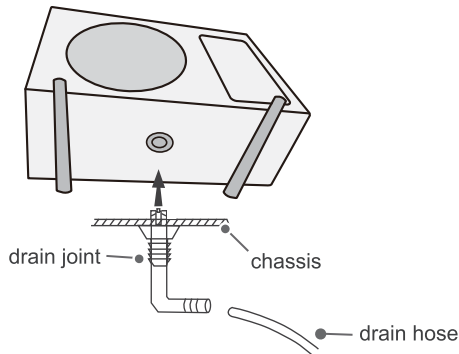

3. Secure the Outdoor Unit

Place the outside unit firmly on the ground or attach it to a secure metal wall bracket or pad (not included). Secure the foot holes of the outdoor unit with the bolts.

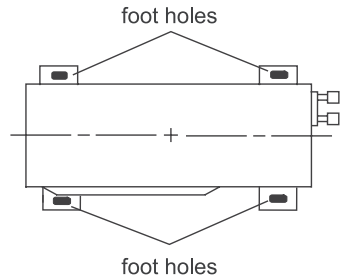

4. Connect the Refrigerant Pipe to Outdoor Unit

- Remove the screw cap of the valve and aim the pipe joint at the bellmouth of pipe.

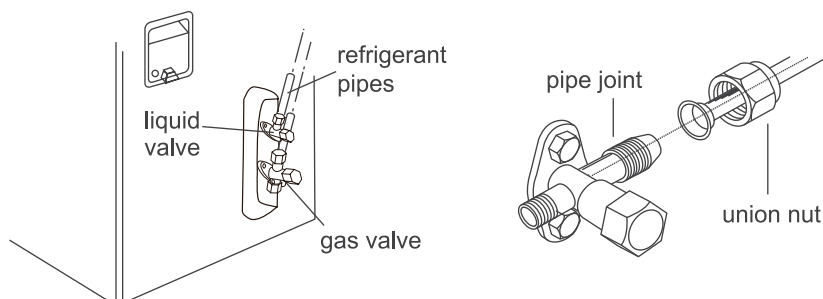

- Align both ends of the refrigerant piping and start to twist on the union nut by hand.
- Use a standard wrench on the pipe joint and an open-end torque wrench on the union nut to apply the proper torque as shown in the torque table below.

Note: Over tightening may damage connections. Carefully tighten union nuts to correct torque level referring to the Torque Table below.

Torque Table

Pipe Diameter	Nut Size	Tightening Torque	
		ft-lbs	N-m
1/4 (6)	1/4 (17)	12 to 14	15 to 20
3/8 (9.5)	3/8 (22)	23 to 29	30 to 40
1/2 (12.7)	1/2 (25)	34 to 40	45 to 55
5/8 (16)	5/8 (29)	45 to 47	60 to 65

Note On Pipe Length

The length of refrigerant piping will affect the performance and energy efficiency of the unit. Nominal efficiency is tested on units with a pipe length of 16.5ft (5 meters). Refer to the table below for specifications on the maximum length.

Capacity (BTU/h)	Min. Length (ft/m)	Max. Length (ft/m)
9000-12000	10 (3)	65 (20)
18000-24000		131 (40)

Refrigerant Piping Connection Instructions

Improper pipe shorten or expanding might cause refrigerant leakage. Please take extra care to cut and flare them properly to ensure the efficient operation and minimize the need for future maintenance.

a. Cut pipes

- Measure the distance between the indoor and outdoor units.
- Using a pipe cutter, cut the pipe a little longer than the measured distance.
- Make sure that the pipe is cut at a perfect 90° angle.

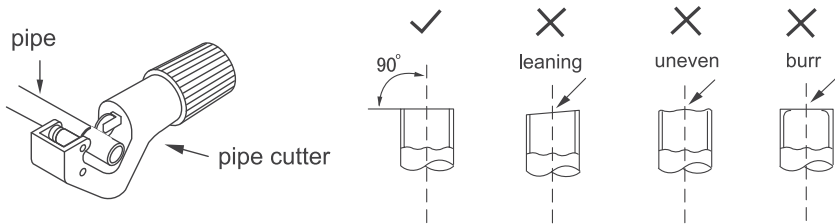

Be extra careful not to damage, dent, or deform the pipe while cutting. This will drastically reduce the heating efficiency of the unit.

b. Remove burrs

Burrs can affect the air-tight seal of refrigerant piping connection. They must be completely removed.

- Hold the pipe at a downward angle to prevent burrs from falling into the pipe.
- Using a reamer or deburring tool, remove all burrs from the cut section of the pipe.

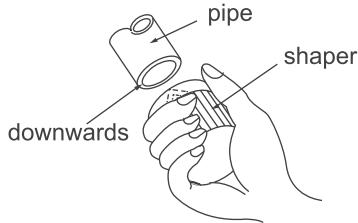

c. Flare pipe ends

- After removing burrs from the cut pipe, seal the ends with tape to prevent foreign materials from entering the pipe.
- Sheath the pipe with insulating material.
- Place flare nuts on both ends of the pipe. Make sure they are facing in the right direction, because you can't put them on or change their direction after flaring.

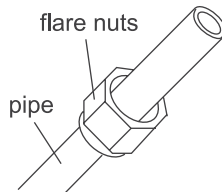

- Remove the tape from ends of pipe when ready to perform flaring work.
- Clamp flare form on the end of the pipe. Place flaring tool onto the form. Turn the handle of the flaring tool clockwise until the pipe is fully flared.

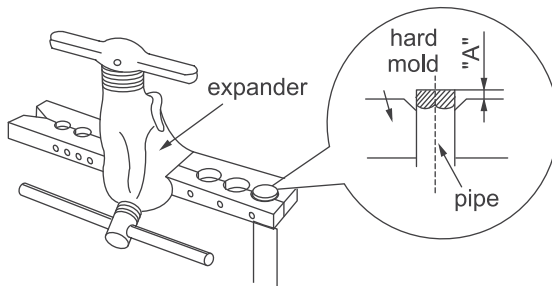

The end of the pipe("A") must extend beyond the edge of the flare form in accordance with the dimensions shown in the table below.

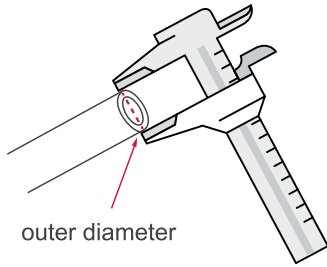

Outer Diameter (mm)	A(mm)	
	Max	Min
Φ6 - 6.35(1/4")	1.3	0.7
Φ9 - 9.52(3/8")	1.6	1.0
Φ12-12.7(1/2")	1.8	1.0
Φ15.8-16(5/8")	2.4	2.2

- Remove the flaring tool and flare form, then inspect the end of the pipe for cracks and even flaring. If there is any blemish, do it again according to the steps above.

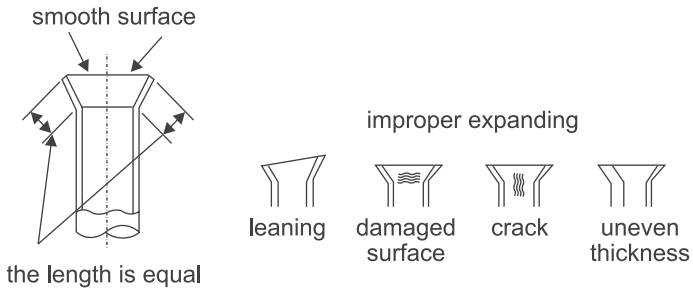

d. Connect pipes

When connecting refrigerant pipes, be careful not to use excessive torque or to deform the piping in any way. You should first connect the low-pressure pipe, then the high-pressure pipe.

5. Connect the Signal and Power Cables

- Remove the wire cover on the outdoor unit. All wiring must be performed in accordance with the wiring diagrams shown below.
- Match the wire colors with the labels on the terminal block and firmly screw the U-Lug of each wire to its corresponding terminal on the terminal block.
- After checking to make sure every connection is secure, loop wires around the terminals to secure the connection.
- Use a cable clamp to fasten the cable to the unit. Screw the cable clamp down tightly.
- Insulate unused wires with PVC electrical tape. Arrange them so that they do not touch any electrical or metal parts.
- Replace the wire cover on the side of the unit and screw it in place.

WIRE CONNECTING DIAGRAM

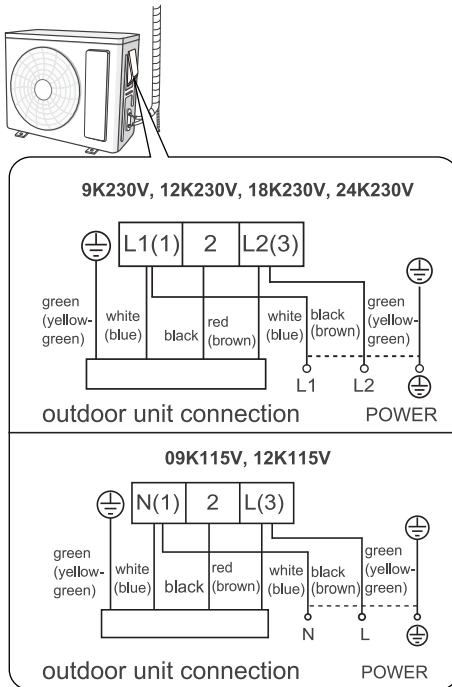

NOTE

1. Make sure the connection is following the instruction. You can make adjustments according to your circuit box at home, if necessary, it is recommended to consult a professional electrician.
2. The wire gauge recommended for this product is listed below.

Model	MCA	Recommended Wire Gauge
SU-AORAKI9-115	19A	AWG 12+
SU-AORAKI9-230	10A	AWG 18+
SU-AORAKI12-115	19A	AWG 12+
SU-AORAKI12-230	10A	AWG 18+
SU-AORAKI18-230	16A	AWG 14+
SU-AORAKI24-230	22A	AWG 12+

Appliance Amps (A)	AWG
10	18
13	16
18	14
25	12
30	10

Capacity (BTU/h)	Connection Wires (Indoor & Outdoor Units)
9000-24000	4×AWG18

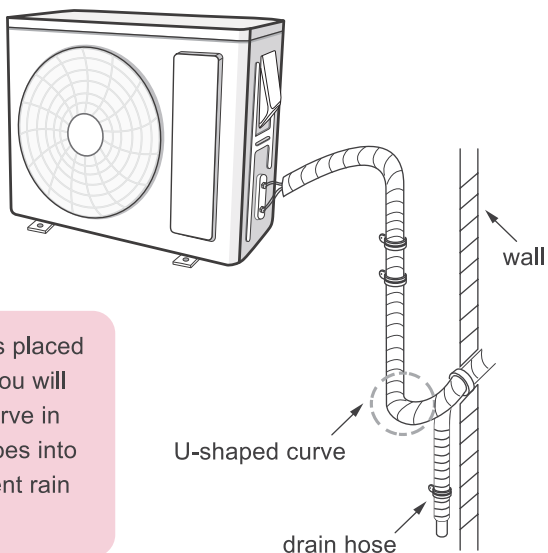

Note: If the outdoor unit is placed higher than the wall hole you will need to set a U-shaped curve in the pipe before the pipe goes into the room, in order to prevent rain from getting into the room.

6. Electrical Safety Inspection

Check the voltage of wires in the electric box, as well as indoor and outdoor unit wiring box.

Model	Indoor Unit	Outdoor Unit and Electrical Box
115V unit	Between terminal N and 2 is within 0-24V. Between terminal 2 and 3 is within 100-140V	Between terminal N and 2 is within 0-24V. Between terminal L and G/N is within 100-140V. Between terminal N and G is 0V.
230V unit	Between terminal 1 and 2 is within 200-250V. Between terminal 2 and 3 is within 200-250V.	Between terminal L1 and 2 is within 0-24V. Between terminal L1/L2 and G is within 100-140V. Between terminal L1 and L2 is 200-250V.

Air Evacuation

Preparations and Precautions

Air and foreign matter in the refrigerant circuit can cause abnormal rises in pressure, which can damage the air conditioner, reduce its efficiency, and cause injury. Use a vacuum pump and manifold gauge to evacuate the refrigerant circuit, removing any non-condensable gas and moisture from the system. Evacuation should be performed upon initial installation or when the unit is relocated.

Evacuation Instructions

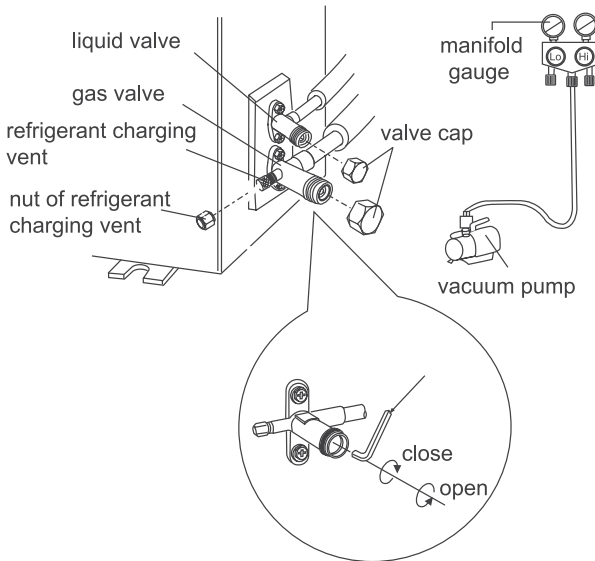

- Remove the valve caps from the liquid valve and gas valve and remove the nut of the refrigerant charging vent.
- Connect the charging hose of the manifold gauge to the refrigerant charging vent of the gas valve and then connect the other charging hose from the manifold gauge to the vacuum pump.
- Open the manifold gauge completely and operate for 10-15min to check if the pressure of the manifold gauge remains in -0.1MPa .

- Close the vacuum pump and wait for 5 minutes to ensure there has been no change in system pressure. If the pressure decreases there may be leakage, please refer to the Gas Leak Check section.
- Remove the manifold gauge, open the valve core of the liquid valve and gas valve completely by turning anticlockwise with a hexagonal allen wrench.
- Tighten the screw caps of the valves and refrigerant charging vent once complete.

Gas Leak Checks

There are two different methods to check for gaseous leaks.

1. Soap and Water Method

Using a soft brush, apply soapy water or liquid detergent to all pipe connection points on the indoor unit and outdoor unit for more than 3 minutes. If there are bubbles coming out, there's a leak.

2. Leak Detector Method

If using a leak detector, refer to the device's operation manual for proper usage instructions.

Note: After confirming that all the pipe connection points DO NOT leak, replace the valve cover on the outside unit.

Electrical Safety Checks

After installation, confirm that all electrical wiring is installed in accordance with local and national regulations, and according to the Installation Manual.

1. Check Grounding Work

Measure grounding resistance by visual detection and with a grounding resistance tester. Grounding resistance must be less than 4 ohms.

Note: This may not be required for some locations in the US.

2. Check for Electrical Leakage

During the Test Run, use an electroprobe and multimeter to perform a comprehensive electrical leakage test.

If electrical leakage is detected, turn off the unit immediately and call a licensed electrician to find and resolve the cause of the leakage.

Note: This may not be required for some locations in the US.

Note: All wiring must comply with local and national electrical codes and must be installed by a licensed electrician.

Test Run

Only perform test run after you have completed the following steps

- Electrical Safety Check – Confirm that the unit's electrical system is safe and operating properly
- Gas Leak Check – Check all flare nut connections and confirm that the system is not leaking
- Confirm that gas and liquid (high and low pressure) valves are fully open

Warranty & Customer Support

Warranty Information

1. 5-Year warranty:

TOSOT Split-type Air Conditioner comes with a 5-year warranty from the date of purchase.

This warranty covers manufacturing and material defects. Please visit <https://tosotdirect.com/warranty> for more details.

2. Additional 6-Month warranty extension:

You can get a 6-month warranty extension by registering your new product at www.tosotdirect.com/extend.

Customer Support

Questions? We are here to help

✉ support@tosotdirect.com

🌐 www.tosotdirect.com



Share your experience



@tosotdirect